



WMF Quadro. Buffet in Ihrem Takt.
Ein modulares Kombinations-Highlight.

WMF Quadro. Buffet to your own beat.
A star of combination.

WMF Quadro. Leuchtende Momente und individuelle Designs.

WMF Quadro. Bright moments and individual designs.



Der Schlüssel zur Individualität liegt insbesondere in der Verwendung des GN-Formats. Kein Buffet gleicht dem anderen. Alles im GN-Format. Für unbegrenzte Möglichkeiten, da alle Elemente gleich funktional sind. Dies eröffnet neue Freiheiten für Ihr System.

Das clevere Buffet-System kann durch Zugabe von Lichtelementen in kürzester Zeit das Ambiente verändern. In der Kunst werden Farben ganz gezielt eingesetzt, um bestimmte Stimmungen und Emotionen hervorzurufen. Diese Idee spiegelt sich in dem unverwechselbaren Look von WMF Quadro wieder. Die LED Lichter, als separater Bestandteil, können einfach und nach eigenem Geschmack in das Modul von WMF Quadro platziert werden. Diese unkomplizierte Handhabung macht das Buffet-System noch attraktiver.

The key to individuality lies especially in the use of the Gastronorm format. No buffet is the same as another. Everything in Gastronorm format. For unlimited options as all of the parts are just as functional. This allows a new freedom for your system.

To beautify the ambience within no time, the well-constructed buffet system can be achieved by light elements. In painting and art, colors are used specifically to evoke certain moods and emotions. This idea is applied to the unique look of the WMF Quadro system. As the lights can be used as separate components, they can be easily placed into the frame of the WMF Quadro system -suitable for your needs. This uncomplicated handling makes the buffet system even more attractive.

Die Einsätze. Aus weißem Porzellan.
20 mm oder 65 mm Höhe. In Holz-
optik, Rauchglas oder Glas satiniert.
Brotkorbeinsatz 80 mm Höhe.

The inserts. Made of white porcelain.
20 or 65 mm high. In a wood look,
grey glass or satin glass.
Bread basket insert 80 mm high.



Die Aufsätze und Konsolen.
Optional. In verschiedenen Größen.
The top frames and consoles.
Optional. In various sizes.

Die Eiswanne.
Optional. 55 mm oder 100 mm Höhe.
The ice pan.
Optional. 55 or 100 mm high.

Der Adapterrahmen. Aus Metall.
Optional als LEDlight Einheit aus
mattem Plexiglas.
The adapter frame. Made of metal.
Optionally as LEDlight unit made of
matt acrylic glass.



Die Rahmen. Aus Edelstahl.
80 mm oder 130 mm Höhe.
The frames. Made of stainless
steel. 80 or 130 mm high.



Ob Frühstücks-, Mittags-, Dessert- oder
Abendbuffet: WMF Quadro macht den
Aufbau besonders leicht. Einzelmodule
und Kombinationen sind mit wenigen
Handgriffen einsatzbereit und sofort
reproduzierbar.

Whether a breakfast, midday, dessert or
evening buffet, WMF Quadro makes it
particularly easy to set up. It takes just
a few touches to get single modules and
combinations ready for use and this can
immediately be reproduced.



Direkt zur eigenen Buffet-Bühne. Mit dem WMF Buffet Konfigurator.

Straight to your own buffet stage.
With the WMF Buffet configurator.

WMF Quadro macht alles einfacher. Auch das Kennenlernen:
Ihr WMF Partner hat den WMF Buffet Konfigurator mobil
im Einsatz und bringt ihn zum Beratungsgespräch bei Ihnen
vor Ort mit. Der Rest geht schnell: Ihre Tischgröße und Form
definieren, 3D-Buffet-Elemente festlegen, nach Ihrem Wunsch
kombinieren und ändern, exportieren – fertig.

WMF Quadro makes it all easier. Even getting to know it. Your
WMF partner has a mobile version of the WMF buffet con-
figurator and will bring it along to offer you advice on your
premises. The rest is really quick. Define the size and shape of
your tables, specify the 3D modules for your buffet, combine
and change them as you wish, export – done.



**Rahmen GN 1/1**

Frame GN 1/1

Cadre GN 1/1

Marco GN 1/1

Telaio GN 1/1

stapelbar, für GN Einsätze, nur in Verbindung mit Adapter 55.0164.6040 oder 55.0211.9900 /

stackable, for inserts GN, only in combination with adapter 55.0164.6040 or 55.0211.9900

Cromargan®, geschliffen / stainless 18/10, grinded

Maße	measures	Höhe	height	
cm	in.	cm	in.	
56,2 x 35,7	22 1/4 x 14 1/2	8	3 1/8	55.0140.6090
56,2 x 35,7	22 1/4 x 14 1/2	13	5 1/8	55.0141.6090

**Rahmen GN 2/3**

Frame GN 2/3

Cadre GN 2/3

Marco GN 2/3

Telaio GN 2/3

stapelbar, für GN Einsätze, nur in Verbindung mit Adapter 55.0165.6040 oder 55.0212.9900 /

stackable, for inserts GN, only in combination with adapter 55.0165.6040 or 55.0212.9900

Cromargan®, geschliffen / stainless 18/10, grinded

Maße	measures	Höhe	height	
cm	in.	cm	in.	
38,6 x 35,7	15 x 14 1/2	8	3 1/8	55.0142.6090
38,6 x 35,7	15 x 14 1/2	13	5 1/8	55.0143.6090

**Rahmen GN 2/4**

Frame GN 2/4

Cadre GN 2/4

Marco GN 2/4

Telaio GN 2/4

stapelbar, für GN Einsätze, nur in Verbindung mit Adapter 55.0166.6040 oder 55.0213.9900 /

stackable, for inserts GN, only in combination with adapter 55.0166.6040 or 55.0213.9900

Cromargan®, geschliffen / stainless 18/10, grinded

Maße	measures	Höhe	height	
cm	in.	cm	in.	
56,2 x 19	22 1/4 x 7	8	3 1/8	55.0144.6090
56,2 x 19	22 1/4 x 7	13	5 1/8	55.0145.6090

**Rahmen GN 1/3**

Frame GN 1/3

Cadre GN 1/3

Marco GN 1/3

Telaio GN 1/3

stapelbar, für GN Einsätze, nur in Verbindung mit Adapter 55.0167.6040 oder 55.0214.9900 /

stackable, for inserts GN, only in combination with adapter 55.0167.6040 or 55.0214.9900

Cromargan®, geschliffen / stainless 18/10, grinded

Maße	measures	Höhe	height	
cm	in.	cm	in.	
20,8 x 35,7	8 7/8 x 14 1/2	8	3 1/8	55.0146.6090
20,8 x 35,7	8 7/8 x 14 1/2	13	5 1/8	55.0147.6090

Adapter GN 1/1

Adapter GN 1/1
 Adaptateur GN 1/1
 Adaptador GN 1/1
 Adattatore GN 1/1

für Rahmen GN 1/1 55.0140.6090 und 55.0141.6090 /
 for frame GN 1/1 55.0140.6090 and 55.0141.6090



Cromargan®, poliert / stainless 18/10, mirror finish
 Maße measures Höhe height
 cm in. cm in.
 56,6 x 36,1 22 1/3 x 14 1/5 1 3/8

55.0164.6040

Adapter GN 2/3

Adapter GN 2/3
 Adaptateur GN 2/3
 Adaptador GN 2/3
 Adattatore GN 2/3

für Rahmen GN 2/3 55.0142.6090 und 55.0143.6090 /
 for frame GN 2/3 55.0142.6090 and 55.0143.6090



Cromargan®, poliert / stainless 18/10, mirror finish
 Maße measures Höhe height
 cm in. cm in.
 39 x 36,1 15 3/4 x 14 1/5 1 3/8

55.0165.6040

Adapter GN 2/4

Adapter GN 2/4
 Adaptateur GN 2/4
 Adaptador GN 2/4
 Adattatore GN 2/4

für Rahmen GN 2/4 55.0144.6090 und 55.0145.6090 /
 for frame GN 2/4 55.0144.6090 and 55.0145.6090



Cromargan®, poliert / stainless 18/10, mirror finish
 Maße measures Höhe height
 cm in. cm in.
 56,6 x 19,4 22 1/3 x 7 2/3 1 3/8

55.0166.6040

Adapter GN 1/3

Adapter GN 1/3
 Adaptateur GN 1/3
 Adaptador GN 1/3
 Adattatore GN 1/3

für Rahmen GN 1/3 55.0146.6090 und 55.0147.6090 /
 for frame GN 1/3 55.0146.6090 and 55.0147.6090



Cromargan®, poliert / stainless 18/10, mirror finish
 Maße measures Höhe height
 cm in. cm in.
 21 x 36,2 8 1/4 x 14 1/4 1 3/8

55.0167.6040



Eiswanne GN 1/1

Ice pan GN 1/1
 Bac à glace GN 1/1
 Coche hielo GN 1/1
 Vasca ghiaccio GN 1/1

spülmaschinengeeignet /
 dishwasher-safe

Kunststoff PMMA, transparent / plastic PMMA, transparent

Maße cm	measures in.	Höhe cm	height in.	
51,9 x 31,4	20 1/4 x 12 5/8	5,5	2 1/8	55.0152.9900
51,9 x 31,4	20 1/4 x 12 5/8	10	4	55.0153.9900



Eiswanne GN 2/3

Ice pan GN 2/3
 Bac à glace GN 2/3
 Coche hielo GN 2/3
 Vasca ghiaccio GN 2/3

spülmaschinengeeignet /
 dishwasher-safe

Kunststoff PMMA, transparent / plastic PMMA, transparent

Maße cm	measures in.	Höhe cm	height in.	
34,3 x 31,4	13 x 12 5/8	5,5	2 1/8	55.0154.9900
34,3 x 31,4	13 x 12 5/8	10	4	55.0155.9900



Eiswanne GN 2/4

Ice pan GN 2/4
 Bac à glace GN 2/4
 Coche hielo GN 2/4
 Vasca ghiaccio GN 2/4

spülmaschinengeeignet /
 dishwasher-safe

Kunststoff PMMA, transparent / plastic PMMA, transparent

Maße cm	measures in.	Höhe cm	height in.	
51,9 x 15,1	20 x 5 1/2	5,5	2 1/8	55.0156.9900
51,9 x 15,1	20 x 5 1/2	10	4	55.0157.9900



Eiswanne GN 1/3

Ice pan GN 1/3
 Bac à glace GN 1/3
 Coche hielo GN 1/3
 Vasca ghiaccio GN 1/3

spülmaschinengeeignet /
 dishwasher-safe

Kunststoff PMMA, transparent / plastic PMMA, transparent

Maße cm	measures in.	Höhe cm	height in.	
31,4 x 16,5	12 5/8 x 6	5,5	2 1/8	55.0158.9900
31,4 x 16,5	12 5/8 x 6	10	4	55.0159.9900



Konsole GN $\frac{3}{6}$

console GN $\frac{3}{6}$
 Console GN $\frac{3}{6}$
 Consola GN $\frac{3}{6}$
 Mensola GN $\frac{3}{6}$

stapelbar /
 stackable

Cromargan®, geschliffen / stainless 18/10, grinded

Maße cm	measures in.	Höhe cm	height in.	
35 (17) x 32 (16)	14 (7) x 13 (6)	5,2	2	55.0170.6090



Konsole GN $\frac{1}{6}$

console GN $\frac{1}{6}$
 Console GN $\frac{1}{6}$
 Consola GN $\frac{1}{6}$
 Mensola GN $\frac{1}{6}$

stapelbar /
 stackable

Cromargan®, geschliffen / stainless 18/10, grinded

Maße cm	measures in.	Höhe cm	height in.	
17,2 x 15,9	6 $\frac{3}{4}$ x 6 $\frac{1}{4}$	5,2	2	55.0171.6090



Konsole GN $\frac{1}{6}$ mit Fuß

console GN $\frac{1}{6}$ with feet
 Console GN $\frac{1}{6}$ avec pied
 Consola GN $\frac{1}{6}$ con pie
 Mensola GN $\frac{1}{6}$ con piede

stapelbar /
 stackable

Cromargan®, geschliffen / stainless 18/10, grinded

Maße cm	measures in.	Höhe cm	height in.	
17,2 x 15,9	6 $\frac{3}{4}$ x 6 $\frac{1}{4}$	9,7	3 $\frac{7}{8}$	55.0173.6090



Konsole GN $\frac{1}{3}$

console GN $\frac{1}{3}$
 Console GN $\frac{1}{3}$
 Consola GN $\frac{1}{3}$
 Mensola GN $\frac{1}{3}$

stapelbar /
 stackable

Cromargan®, geschliffen / stainless 18/10, grinded

Maße cm	measures in.	Höhe cm	height in.	
17,2 x 32,1	6 $\frac{3}{4}$ x 12 $\frac{5}{8}$	5,2	2	55.0172.6090

Konsole GN 2/4

console GN 2/4
 Console GN 2/4
 Consola GN 2/4
 Mensola GN 2/4

stapelbar /
 stackable

Cromargan®, geschliffen / stainless 18/10, grinded

Maße	measures	Höhe	height	
cm	in.	cm	in.	
52,5 x 15,6	20 5/8 x 6 1/8	5,2	2	55.0174.6090



Brottschneidebrett GN 1/1

Bread cutting board GN 1/1
 Planche à pain GN 1/1
 Tabla de cortar pan GN 1/1
 Tagliere per pane GN 1/1

Holz Eiche / wood oak

Maße	measures	Höhe	height	
cm	in.	cm	in.	
53 x 32,5	21 x 13	1,9	3/4	55.0198.9900



Platte GN 1/1

Plate GN 1/1
 Plaque GN 1/1
 Plato GN 1/1
 Piatto GN 1/1



	Maße	measures	Höhe	height	
	cm	in.	cm	in.	
Rauchglas einseitig mit Struktur / one-sided smoked glass with texture	53,0 x 32,5	21 x 13	0,5	1/4	55.0175.9900
Melamin > Holzoptik / melamine > wood finish	53,0 x 32,5	21 x 13	0,5	1/4	55.0176.9900
Glas transparent einseitig satiniert / glass transparent one-sided satinized	53,0 x 32,5	21 x 13	0,5	1/4	55.0177.9900

Platte GN 2/3

Plate GN 2/3
 Plaque GN 2/3
 Plato GN 2/3
 Piatto GN 2/3



	Maße	measures	Höhe	height	
	cm	in.	cm	in.	
Rauchglas einseitig mit Struktur / one-sided smoked glass with texture	35,4 x 32,5	14 x 13	0,5	1/4	55.0178.9900
Melamin > Holzoptik / melamine > wood finish	35,4 x 32,5	14 x 13	0,5	1/4	55.0179.9900
Glas transparent einseitig satiniert / glass transparent one-sided satinized	35,4 x 32,5	14 x 13	0,5	1/4	55.0180.9900

Platte GN ²/₄

Plate GN ²/₄

Plaque GN ²/₄

Plato GN ²/₄

Piatto GN ²/₄



	Maße cm	measures in.	Höhe cm	height in.	
Rauchglas einseitig mit Struktur / one-sided smoked glass with texture	53,0 x 16,2	21 x 6 ² / ₃	0,5	¹ / ₄	55.0181.9900
Melamin > Holzoptik / melamine > wood finish	53,0 x 16,2	21 x 6 ² / ₃	0,5	¹ / ₄	55.0182.9900
Glas transparent einseitig satiniert / glass transparent one-sided satinized	53,0 x 16,2	21 x 6 ² / ₃	0,5	¹ / ₄	55.0183.9900

Platte GN ¹/₃

Plate GN ¹/₃

Plaque GN ¹/₃

Plato GN ¹/₃

Piatto GN ¹/₃



	Maße cm	measures in.	Höhe cm	height in.	
Rauchglas einseitig mit Struktur / one-sided smoked glass with texture	17,6 x 32,5	7 x 13	0,5	¹ / ₄	55.0184.9900
Melamin > Holzoptik / melamine > wood finish	17,6 x 32,5	7 x 13	0,5	¹ / ₄	55.0185.9900
Glas transparent einseitig satiniert / glass transparent one-sided satinized	17,6 x 32,5	7 x 13	0,5	¹ / ₄	55.0186.9900

Platte GN ³/₆

Plate GN ³/₆

Plaque GN ³/₆

Plato GN ³/₆

Piatto GN ³/₆



	Maße cm	measures in.	Höhe cm	height in.	
Rauchglas einseitig mit Struktur / one-sided smoked glass with texture	35 (17) x 32 (16)	14 (7) x 13 (7)	0,5	¹ / ₄	55.0193.9900
Melamin > Holzoptik / melamine > wood finish	35 (17) x 32 (16)	14 (7) x 13 (7)	0,5	¹ / ₄	55.0194.9900
Glas transparent einseitig satiniert / glass transparent one-sided satinized	35 (17) x 32 (16)	14 (7) x 13 (7)	0,5	¹ / ₄	55.0195.9900



Brotkorb GN 1/1

Bread basket GN 1/1
 Corbeille à pain GN 1/1
 Panera GN 1/1
 Cestino portapane GN 1/1

spülmaschinengeeignet /
 dishwasher-safe

Kunststoffgeflecht PP / plastic meshwork PP

Maße cm	measures in.	Höhe cm	height in.	
53 x 32,5	21 x 13	8	3 1/8	55.0202.9900



Brotkorb GN 2/3

Bread basket GN 2/3
 Corbeille à pain GN 2/3
 Panera GN 2/3
 Cestino portapane GN 2/3

spülmaschinengeeignet /
 dishwasher-safe

Kunststoffgeflecht PP / plastic meshwork PP

Maße cm	measures in.	Höhe cm	height in.	
35,4 x 32,5	14 x 13	8	3 1/8	55.0203.9900



Brotkorb GN 2/4

Bread basket GN 2/4
 Corbeille à pain GN 2/4
 Panera GN 2/4
 Cestino portapane GN 2/4

spülmaschinengeeignet /
 dishwasher-safe

Kunststoffgeflecht PP / plastic meshwork PP

Maße cm	measures in.	Höhe cm	height in.	
53 x 16,2	21 x 6 2/3	8	3 1/8	55.0204.9900



Brotkorb GN 1/3

Bread basket GN 1/3
 Corbeille à pain GN 1/3
 Panera GN 1/3
 Cestino portapane GN 1/3

spülmaschinengeeignet /
 dishwasher-safe

Kunststoffgeflecht PP / plastic meshwork PP

Maße cm	measures in.	Höhe cm	height in.	
17,6 x 32,5	7 x 13	8	3 1/8	55.0205.9900

Brotkorb GN 1/2

Bread basket GN 1/2
Corbeille à pain GN 1/2
Panera GN 1/2
Cestino portapane GN 1/2

spülmaschinengeeignet /
dishwasher-safe



Kunststoffgeflecht PP / plastic meshwork PP

Maße cm	measures in.	Höhe cm	height in.
26,5 x 32,5	7 x 13	8	3 1/8

55.0209.9900

Aufsatz GN 1/2

top frame GN 1/2
Corniche GN 1/2
Suplemento GN 1/2
Accessorio GN 1/2

auf/on GN 1/1, GN 2/3



Cromargan®, geschliffen / stainless 18/10, grinded

Maße cm	measures in.	Höhe cm	height in.
34,1 x 25	13 1/2 x 9 7/8	25	9 7/8

55.0206.6090

Aufsatz GN 1/3

top frame GN 1/3
Corniche GN 1/3
Suplemento GN 1/3
Accessorio GN 1/3

auf/on GN 1/1, GN 2/3, GN 1/3



Cromargan®, geschliffen / stainless 18/10, grinded

Maße cm	measures in.	Höhe cm	height in.
34,1 x 16,1	13 1/2 x 6 2/3	17	6 3/4

55.0207.6090

Brücke GN 2/4

Bridge GN 2/4
Pont GN 2/4
Punte GN 2/4
Ponte GN 2/4

für GN 2/4 Einsätze /
for inserts GN 2/4



Cromargan®, geschliffen / stainless 18/10, grinded

Maße cm	measures in.	Höhe cm	height in.
64 x 20	25 x 8	30,8	12 1/8

55.0208.6090



Etagere GN 1/1

Serving stand GN 1/1
 Etagère GN 1/1
 Etageré GN 1/1
 Alzata GN 1/1

für GN Einsätze, in Glas, Porzellan und Holzoptik /
 for inserts GN, in glass, porcelain and wood optics

Cromargan®, geschliffen / stainless 18/10, grinded

Maße	measures	Höhe	height
cm	in.	cm	in.
51,7 x 36	20 1/2 x 14 1/4	50	19 3/4

55.0210.6090



LEDlight Einheit

LEDlight unit
 Unitéampoule LED
 LEDluz unidad
 LEDlight Unità

mit Fernbedienung, Akku und Ladeeinheit, div. Lichtfarben einstellbar,
 dimmbar /

with remote control, battery and charging unit, various light colors
 adjustable, dimmable

Kunststoff transluzent / translucent plastic

Maße	measures	Höhe	height
cm	in.	cm	in.
Ø 9,3	Ø 3 5/8	2,6	1

55.0230.9900



LEDlight Adapter GN 1/1

LEDlight adapter GN 1/1
 Adaptateurampoule LED GN 1/1
 LEDluz Adaptador GN 1/1
 LEDlight Adattatore GN 1/1

für Rahmen GN 55.0140.6090 und 55.0141.6090 /
 for frame GN 55.0140.6090 and 55.0141.6090

Kunststoff transluzent / translucent plastic

Maße	measures	Höhe	height
cm	in.	cm	in.
56,5 x 36,1	22 1/4 x 14 1/4	1,5	5/8

55.0211.9900



LEDlight Adapter GN 2/3

LEDlight adapter GN 2/3
 Adaptateurampoule LED GN 2/3
 LEDluz Adaptador GN 2/3
 LEDlight Adattatore GN 2/3

für Rahmen GN 55.0142.6090 und 55.0143.6090 /
 for frame GN 55.0142.6090 and 55.0143.6090

Kunststoff transluzent / translucent plastic

Maße	measures	Höhe	height
cm	in.	cm	in.
39 x 36,1	15 1/3 x 14 1/4	1,5	5/8

55.0212.9900



LEDlight Adapter GN $\frac{2}{4}$

LEDlight adapter GN $\frac{2}{4}$
 AdaptateurampouleLED GN $\frac{2}{4}$
 LEDluz Adaptador GN $\frac{2}{4}$
 LEDlight Adattatore GN $\frac{2}{4}$

für Rahmen GN 55.0144.6090 und 55.0145.6090 /
 for frame GN 55.0144.6090 and 55.0145.6090

Kunststoff transluzent / translucent plastic

Maße	measures	Höhe	height	
cm	in.	cm	in.	
56,5 x 19,6	22 $\frac{1}{4}$ x 7 $\frac{3}{4}$	1,5	$\frac{5}{8}$	55.0213.9900



LEDlight Adapter GN $\frac{1}{3}$

LEDlight adapter GN $\frac{1}{3}$
 AdaptateurampouleLED GN $\frac{1}{3}$
 LEDluz Adaptador GN $\frac{1}{3}$
 LEDlight Adattatore GN $\frac{1}{3}$

für Rahmen GN 55.0146.6090 und 55.0147.6090 /
 for frame GN 55.0146.6090 and 55.0147.6090

Kunststoff transluzent / translucent plastic

Maße	measures	Höhe	height	
cm	in.	cm	in.	
21,2 x 36,1	8 $\frac{1}{4}$ x 14 $\frac{1}{4}$	1,5	$\frac{5}{8}$	55.0214.9900



Porzellaneinsatz GN $\frac{3}{6}$

porcelain insert GN $\frac{3}{6}$
 Incrustation porcelaine GN $\frac{3}{6}$
 Interior de porcelana GN $\frac{3}{6}$
 Inserto porcellana GN $\frac{3}{6}$

Größe	size	Inhalt	cap.	Höhe	height	
cm	in.	Ltr.	oz.	cm	in.	
35,4 / 17,4 x	14 (7) x	0,7	24,5	2	$\frac{3}{4}$	55.0219.9800
32,5 / 16,2	12 $\frac{3}{4}$ (6 $\frac{1}{3}$)					
35,4 / 17,4 x	14 (7) x	2,5	87,5	6,5	2 $\frac{1}{2}$	55.0220.9800
32,5 / 16,2	12 $\frac{3}{4}$ (6 $\frac{1}{3}$)					

Weitere Auswahl an Einsätzen auf Seite 228
 More inserts available on page 228



Porzellaneinsatz GN $\frac{1}{4}$

porcelain insert GN $\frac{1}{4}$
 Incrustation porcelaine GN $\frac{1}{4}$
 Interior de porcelana GN $\frac{1}{4}$
 Inserto porcellana GN $\frac{1}{4}$

Größe	size	Inhalt	cap.	Höhe	height	
cm	in.	Ltr.	oz.	cm	in.	
26,5 x 16,2	10 $\frac{1}{2}$ x 6 $\frac{2}{3}$	1,2	40,6	6,5	2 $\frac{1}{2}$	55.0226.9800

Weitere Auswahl an Einsätzen auf Seite 228
 More inserts available on page 228

Porzellaneinsatz GN 1/6

porcelain insert GN 1/6
 Incrustation porcelaine GN 1/6
 Interior de porcelana GN 1/6
 Inserto porcellana GN 1/6

Größe cm	size in.	Inhalt Ltr.	cap. oz.	Höhe cm	height in.	
16,2 x 17,5	6 1/3 x 7	0,86	29,1	6,5	2 1/2	55.0222.9800



Weitere Auswahl an Einsätzen auf Seite 228
 More inserts available on page 228

Hygieneschutz

hygienic cover
 Protection hygiénique
 Protección higiénica
 Protezione igienica

Cromargan®, geschliffen, Kunststoff transparent /
 stainless 18/10, grinded / transparent plastic

Maße cm	measures in.	Höhe cm	height in.	
115 x 30,4	45 1/4 x 12	52	20 1/2	55.0227.6090



Beschriftunghalter hinten

Label holder rear
 Support pour inscription arrière
 Soporte para etiqueta parte trasera
 Supporto etichetta posteriore

Kunststoff transparent / transparent plastic

Maße cm	measures in.	Höhe cm	height in.	
8 x 4,6	3 1/8 x 1 7/8	1,9	3/4	55.0229.9900



Beschriftunghalter vorne

Label holder front
 Support pour inscription avant
 Soporte para etiqueta parte delantera
 Supporto etichetta anteriore

Kunststoff transparent / transparent plastic

Maße cm	measures in.	Höhe cm	height in.	
8 x 4,8	3 1/8 x 1 3/4	1,4	1/2	55.0228.9900



Der neue WMF Chafing Dish HOT & FRESH GN 1/1. Der große Buffet-Hotspot. Mit dem richtigen Durchblick.

The brand new WMF HOT & FRESH chafing dish GN 1/1.
The big player on your buffet. With the good looks to show.



NEU | NEW

Der neue WMF HOT & FRESH GN 1/1 beweist Größe in seiner Kategorie. Er leistet sowohl mit Induktionsheizung als auch auf jeder anderen Standard-Wärmequelle tadellose Arbeit. Mit seinem transparenten Glasdeckel sieht er nicht nur gut aus. Er lässt auch die Speisen bestmöglich im Blick behalten. Hitzebeständige Griffe und gastronomietaugliche Materialien erleichtern die Arbeitsabläufe.

The new WMF HOT & FRESH GN 1/1 works perfectly with induction heating or with any other commonly used heat source. The lid is clear glass, so it doesn't just look good, it allows an excellent view of the food as well. Heat-resistant handles and catering-grade materials help keep workflows progressing smoothly.



Buffetgestell NEUTRAL
buffet stand NEUTRAL



Buffetgestell MANHATTAN
buffet stand MANHATTAN



Buffetgestell BASIC
buffet stand BASIC

Induktion und Intuition.

Ein gekapselter Transtherm®-Boden mit Aluminiumkern, das intelligente Rücklaufsystem für Kondenswasser und ein umfangreiches Zubehör – WMF Chafing Dishes HOT & FRESH zeichnen sich durch ihre besondere Funktionalität und Flexibilität aus. Auf alle Produkte der WMF CHANGE Kollektion abgestimmt, lassen sie sich vielseitig kombinieren.

Induction and intuition.

An encapsulated Transtherm® base with aluminium core, the smart return system for condensation and an extensive choice of accessories – WMF HOT & FRESH chafing dishes are characterised by their superb functionality and versatility. Matched to all the products in the WMF CHANGE collection, they can be combined in lots of different ways.

High End Design made in Germany.

Hochwertige Bremsen sorgen dafür, dass der Lauf des Deckels optimal gedämpft wird. Er lässt sich spielend leicht öffnen, bleibt stufenlos stehen und ist ganz soft wieder verschließbar.

High-end design made in Germany.

High-quality brakes keep the movement of the lid optimally slow. The lid opens at a touch, stays open at any angle, and closes again softly to reseal perfectly.

Immer in passender Form.

Die WMF Chafing Dishes HOT & FRESH gibt es rund und rechteckig in GN 2/3- und GN 1/1-Größe, passend für Einsätze bis zehn Zentimeter Tiefe.

Always in great shape.

WMF HOT & FRESH chafing dishes are available round or rectangular in GN 2/3 and GN 1/1 size, compatible with inserts up to ten cm in depth.

Produktvarianten
Product variants



rund
round

GN 2/3
GN 2/3



GN 1/1
GN 1/1



Ausführungen CHANGE
CHANGE models



HOT & FRESH „BASIC“

HOT & FRESH „MANHATTAN“

HOT & FRESH „PALAST“

(Sonderausführung auf Anfrage.
Special design on request.)

Abbildung Chafing Dishes HOT & FRESH „BASIC“ auf Buffetgestell NEUTRAL.
Illustration HOT & FRESH 'BASIC' chafing dishes on NEUTRAL buffet stands.

**Chafing Dish, „Basic“, GN 1/1
HOT & FRESH**

Chafing Dish, „Basic“, GN 1/1
Chafing Dish, „Basic“, GN 1/1
Chafing Dish, „Basic“, GN 1/1
Chafing Dish, „Basic“, GN 1/1

passend für Einsätze bis Tiefe 10 cm, induktionsgeeignet, alternativ mit Heizplatte und Brennstoff beheizbar, Glasdeckel mit Bremse abnehmbar, Bügelgriff /
for inserts up to depth 10 cm / 4 in., inductive, electrically and sterno heating possible, glass lid with break removable, bow handle

Cromargan®, Glas / stainless 18/10, glass

Größe	size
cm	in.
58 x 47 x 19	22 3/4 x 18 1/2 x 7 1/2

55.0128.6040



**Chafing Dish, „Manhattan“, GN 1/1
HOT & FRESH**

Chafing Dish, „Manhattan“, GN 1/1
Chafing Dish, „Manhattan“, GN 1/1
Chafing Dish, „Manhattan“, GN 1/1
Chafing Dish, „Manhattan“, GN 1/1

passend für Einsätze bis Tiefe 10 cm, induktionsgeeignet, alternativ mit Heizplatte und Brennstoff beheizbar, Glasdeckel mit Bremse abnehmbar, Griff 4-Kantprofil (matt) /
for inserts up to depth 10 cm / 4 in., inductive, electrically and sterno heating possible, glass lid with break removable, bow handle, stainless steel polished, handle profile 4-cornered (satin finished)

Cromargan®, Glas / stainless 18/10, glass

Größe	size
cm	in.
58 x 47 x 19	22 3/4 x 18 1/2 x 7 1/2

55.0129.6040



**Chafing Dish, „Basic“, GN 2/3
HOT & FRESH**

Chafing Dish, „Basic“, GN 2/3
Chafing Dish, „Basic“, GN 2/3
Chafing Dish, „Basic“, GN 2/3
Chafing Dish, „Basic“, GN 2/3

passend für Einsätze bis Tiefe 10 cm, induktionsgeeignet, alternativ mit Heizplatte und Brennstoff beheizbar, Glasdeckel mit Bremse abnehmbar, Bügelgriff /
fitting for inserts up to depth 10 cm / 4 in., inductive, electrically and sterno heating possible, glass lid with brake removable, bow handle

Cromargan®, Glas / stainless 18/10, glass

Größe	size
cm	in.
37 x 45 x 19	14 1/2 x 17 3/4 x 7 1/2

55.0002.6040





**Chafing Dish, „Manhattan“, GN 2/3
HOT & FRESH**

Chafing Dish, „Manhattan“, GN 2/3
Chafing Dish, „Manhattan“, GN 2/3
Chafing Dish, „Manhattan“, GN 2/3
Chafing Dish, „Manhattan“, GN 2/3

passend für Einsätze bis Tiefe 10 cm, induktionsgeeignet, alternativ mit Heizplatte und Brennstoff beheizbar, Glasdeckel mit Bremse abnehmbar, Griff 4-Kantprofil (mattiert) / fitting for inserts up to depth 10 cm / 4 in., inductive, electrically and sterno heating possible, glass lid with brake removable, handle profile 4-cornered (satin finished)

Cromargan®, Glas / stainless 18/10, glass

Größe	size
cm	in.
37 x 45 x 19	14 1/2 x 17 3/4 x 7 1/2

55.0021.6040



**Chafing Dish, „Basic“, rund
HOT & FRESH**

Chafing Dish, „Basic“, round
Chafing Dish, „Basic“, rond
Chafing Dish, „Basic“, redondo
Chafing Dish, „Basic“, rotondo

passend für Einsätze bis Tiefe 10 cm, induktionsgeeignet, alternativ mit Heizplatte und Brennstoff beheizbar, Glasdeckel mit Bremse abnehmbar, Bügelgriff / fitting for inserts up to depth 10 cm / 4 in., inductive, electrically and sterno heating possible, glass lid with brake removable, bow handle

Cromargan®, Glas / stainless 18/10, glass

Höhe	height	Ø	Ø
cm	in.	cm	in.
19	7 1/2	39	15 1/4

55.0001.6040



**Chafing Dish, „Manhattan“, rund
HOT & FRESH**

Chafing Dish, „Manhattan“, round
Chafing Dish, „Manhattan“, rond
Chafing Dish, „Manhattan“, redondo
Chafing Dish, „Manhattan“, rotondo

passend für Einsätze bis Tiefe 10 cm, induktionsgeeignet, alternativ mit Heizplatte und Brennstoff beheizbar, Glasdeckel mit Bremse abnehmbar, Griff 4-Kantprofil (mattiert) / fitting for inserts up to depth 10 cm / 4 in., inductive, electrically and sterno heating possible, glass lid with brake removable, handle profile 4-cornered (satin finished)

Cromargan®, Glas / stainless 18/10, glass

Höhe	height	Ø	Ø
cm	in.	cm	in.
19	7 1/2	39	15 1/4

55.0020.6040

**Buffetgestell, GN 1/1
HOT & FRESH**

frame, GN 1/1
bati, GN 1/1
soporte buffet, GN 1/1
telaio, GN 1/1

für Heizplatte und Brennstoff, passend zu allen Chafing Dishes GN 1/1
HOT & FRESH /
for electrically and sterno heating, fitting for all chafing dishes GN 1/1
HOT & FRESH

Cromargan®, poliert / stainless 18/10, mirror finish

Größe	size
cm	in.
58 x 37 x 17	22 3/4 x 14 1/2 x 6 3/4

55.0137.6040



**Buffetgestell, „Basic“, GN 1/1
HOT & FRESH**

frame, „Basic“, GN 1/1
bati, „Basic“, GN 1/1
soporte buffet, „Basic“, GN 1/1
telaio, „Basic“, GN 1/1

für Heizplatte und Brennstoff, Füße Rundprofil /
for electrically and sterno heating, feet profile round

Cromargan®, poliert / stainless 18/10, mirror finish

Größe	size
cm	in.
65 x 37 x 24	25 1/2 x 14 1/2 x 9 1/2

55.0130.6040

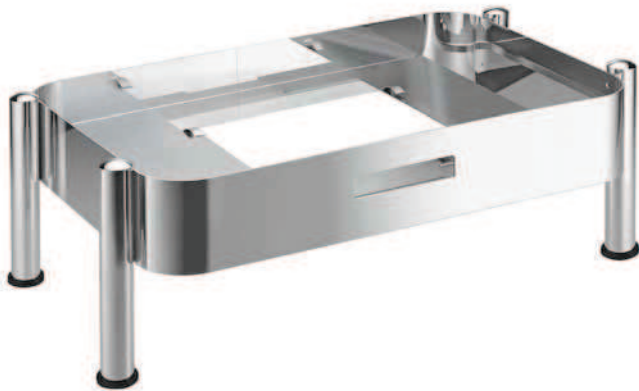

**Buffetgestell, „Manhattan“, GN 1/1
HOT & FRESH**

frame, „Manhattan“, GN 1/1
bati, „Manhattan“, GN 1/1
soporte buffet, „Manhattan“, GN 1/1
telaio, „Manhattan“, GN 1/1

für Heizplatte und Brennstoff, Füße 4-Kantprofil (mattiert) /
for electrically and sterno heating, feet profile 4-cornered (satin
finished)

Cromargan®, poliert / stainless 18/10, mirror finish

Größe	size
cm	in.
66 x 37 x 24	26 1/2 x 14 1/2 x 9 1/2

55.0131.6040





**Buffetgestell, GN 2/3
HOT & FRESH**

frame, GN 2/3
bati, GN 2/3
soporte buffet, GN 2/3
telaio, GN 2/3

für Heizplatte und Brennstoff, passend zu allen Chafing Dishes GN 2/3
HOT & FRESH /
for electrically and sterno heating, fitting for all chafing dishes GN 2/3
HOT & FRESH

Cromargan® / stainless 18/10

Größe	size
cm	in.
37 x 40 x 17	14 1/2 x 15 3/4 x 6 3/4

55.0006.6040



**Buffetgestell, „Basic“, GN 2/3
HOT & FRESH**

frame, „Basic“, GN 2/3
bati, „Basic“, GN 2/3
soporte buffet, „Basic“, GN 2/3
telaio, „Basic“, GN 2/3

für Heizplatte und Brennstoff, Füße Rundprofil /
for electrically and sterno heating, feet profile round

Cromargan® / stainless 18/10

Größe	size
cm	in.
44 x 40 x 24	17 1/4 x 15 3/4 x 9 1/2

55.0012.6040



**Buffetgestell, „Manhattan“, GN 2/3
HOT & FRESH**

frame, „Manhattan“, GN 2/3
bati, „Manhattan“, GN 2/3
soporte buffet, „Manhattan“, GN 2/3
telaio, „Manhattan“, GN 2/3

für Heizplatte und Brennstoff, Füße 4-Kantprofil (mattiert) /
for electrically and sterno heating, feet profile 4-cornered (satin
finished)

Cromargan® / stainless 18/10

Größe	size
cm	in.
44 x 40 x 24	17 1/4 x 15 3/4 x 9 1/2

55.0013.6040

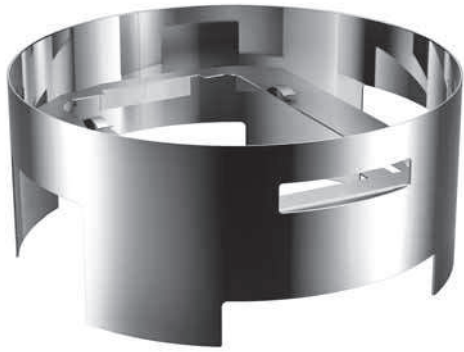

**Buffetgestell, rund
HOT & FRESH**

frame, round
bati, rond
soporte buffet, redondo
telaio, rotondo

für Heizplatte und Brennstoff, passend zu allen runden Chafing Dishes
HOT & FRESH /
for electrically and sterno heating, fitting for all round chafing dishes
HOT & FRESH

Cromargan® / stainless 18/10

Höhe	height	Ø	Ø
cm	in.	cm	in.
17	6 ³ / ₄	39	15 ¹ / ₄

55.0005.6040



**Buffetgestell, „Basic“, rund
HOT & FRESH**

frame, „Basic“, round
bati, „Basic“, rond
soporte buffet, „Basic“, redondo
telaio, „Basic“, rotondo

für Heizplatte und Brennstoff, Füße Rundprofil /
for electrically and sterno heating, feet profile round

Cromargan® / stainless 18/10

Höhe	height	Ø	Ø
cm	in.	cm	in.
24	9 ¹ / ₂	47	18 ¹ / ₂

55.0007.6040



**Buffetgestell, „Manhattan“, rund
HOT & FRESH**

frame, „Manhattan“, round
bati, „Manhattan“, rond
soporte buffet, „Manhattan“, redondo
telaio, „Manhattan“, rotondo

für Heizplatte und Brennstoff, Füße 4-Kantprofil (mattiert) /
for electrically and sterno heating, feet profile 4-cornered (satin
finished)

Cromargan® / stainless 18/10

Höhe	height	Ø	Ø
cm	in.	cm	in.
24	9 ¹ / ₂	47	18 ¹ / ₂

55.0008.6040

WMF CHANGE Chafing Dishes: Freie Hand am Buffet. Von allen Seiten.

WMF CHANGE chafing dishes:
One hand free at the buffet. From all sides.



Die WMF CHANGE Chafing Dishes gehen Hand in Hand mit einem reibungslosen Ablauf am Buffet, denn sie sind besonders einfach bedienbar, hygienisch und ganzheitlich durchdacht. Ihre Rolltop-Deckel lassen sich nahezu geräuschlos und leicht auf und zu schieben, so dass immer eine Hand für den Teller und die Speisen frei bleibt. Nichts muss umständlich abgestellt oder wieder zugedeckt werden. Das spart Zeit, Energie und hebt die Laune.

The WMF CHANGE chafing dishes go hand in hand with smooth proceedings at the buffet due to being outstandingly user-friendly, hygienic and well-designed. The roll-top lids slide open and closed almost soundlessly and with the easy action that leaves one hand free for plate and goodies. Nothing has to be awkwardly set down or covered over again. This helps save time and energy and lifts the mood.

Einfach und sorglos zu bedienen.

Kein Tropfen, keine Wasserrückstände auf dem Tisch, dafür hitzeisolierte Griffe. Und die Deckel der WMF CHANGE Chafing Dishes mit integriertem Kondenswasserrücklauf sind komplett versenkbar. Sie schwingen außerhalb des Drehpunktes um den Brennstoffdosenhalter oder die Heizplatte vollständig unter den Behälter. So sind die Speisen von allen Seiten zugänglich und die Belüftung der Flamme ist stets gewährleistet.

Handle without care.

No drips, no water marking the table; thermally insulated handles instead. And the lids of the WMF CHANGE chafing dishes with integral condensation return are fully retractable. They swing outside the pivot point round the fuel-can holder or the hotplate and pass completely underneath the containers. So the dishes are accessible from all sides and the flame is never choked for air.

Lässt sich mit Links öffnen.

Ergonomisch durchdacht garantiert eine spezielle Kabelführung auch beim Einsatz eines elektrischen Heizteiles, dass sich der Deckel problemlos öffnen lässt. Leichtgängige, stufenlose Bremsen sorgen dafür, dass der Lauf des Deckels optimal gedämpft wird. Für ein spielend einfaches Öffnen, Schließen und Arretieren. Alle Modelle, außer Manhattan, lassen sich platz sparend stapeln.

Opens at the lightest touch.

A model of ergonomics in practice, a special cable guide allows the lid to open easily even when an electric heating element is in use. Smooth-acting, stepless brakes keep the movement of the lid optimally slow. For totally convenient opening, closing and stopping. All models, except the Manhattan, are stackable to save space.



Produktvarianten
Product variants



GN 1/1
GN 1/1



rund
round

Ausführungen CHANGE
CHANGE models



„BASIC“



„MANHATTAN“



„METROPOLITAIN“





Chafing Dish, "Basic"

CHANGE

Chafing Dish, "Basic"
 Chafing Dish, "Basic"
 Chafing Dish, "Basic"
 Chafing Dish, "Basic"

passend für Einsätze bis Tiefe 10 cm /
 fitting for inserts up to depth 4 in.

GN 1/1, Rolltopdeckel, elektrisch und Brennstoff beheizbar, Deckel versenkbar /
 GN 1/1, full rolltop cover, electrically and sterno heated, cover immersible

Cromargan®, Füße Rundprofil, Bügelgriffe /
 stainless 18/10, feet profil round, with bow handles
 ohne Einsätze / w/o inserts

Höhe cm	height in.	Größe mit Griffen cm	size with handles in.
45,6	18	74 x 38	28 1/4 x 15

06.3333.6041

Zubehör / accessory:

Heizelement/ heating element 230 V / 600 W	55.0097.6044
Heizelement/ heating element 120 V / 600 W	55.0097.9990
Heizelement mit Regler/ heating element adjustable 230 V / 700 W	06.3286.6046
Brennstoffdosenhalter / burner holder	06.3322.6039



Chafing Dish, "Metropolitan"

CHANGE

Chafing Dish, "Metropolitan"
 Chafing Dish, "Metropolitan"
 Chafing Dish, "Metropolitan"
 Chafing Dish, "Metropolitan"

passend für Einsätze bis Tiefe 10 cm /
 fitting for inserts up to depth 4 in.

GN 1/1, Rolltopdeckel, elektrisch und Brennstoff beheizbar, Deckel versenkbar /
 GN 1/1, full rolltop cover, electrically and sterno heated, cover immersible

Cromargan®, Füße Rundprofil, Kugelgriffe /
 stainless 18/10, feet profil round, with knob handles
 ohne Einsätze / w/o inserts

Höhe cm	height in.	Größe mit Griffen cm	size with handles in.
45,6	18	74 x 38	28 1/4 x 15

06.3330.6041

Zubehör / accessory:

Heizelement/ heating element 230 V / 600 W	55.0097.6044
Heizelement/ heating element 120 V / 600 W	55.0097.9990
Heizelement mit Regler/ heating element adjustable 230 V / 700 W	06.3286.6046
Brennstoffdosenhalter / burner holder	06.3322.6039

Bitte Heizelement und Brennstoffdosenhalter separat bestellen. Einzelteile (Seite 231) /
 Please order heating elements and burner holder separately. Spare parts (page 231)

Chafing Dish, "Metropolitan", rund CHANGE

Chafing Dish, "Metropolitan", round
Chafing Dish, "Metropolitan", rond
Chafing Dish, "Metropolitan", redondo
Chafing Dish, "Metropolitan", rotondo

passend für Einsätze bis Tiefe 10 cm /
fitting for inserts up to depth 4 in.

rund, Rolltopdeckel, elektrisch und Brennstoff beheizbar, Deckel
versenkbar /
round, full rolltop cover, electrically and sterno heated, cover
immersible

Cromargan®, Füße Rundprofil, Kugelgriff /
stainless 18/10, feet profil round, with knob handle

Höhe	height	Ø	Ø
cm	in.	cm	in.
46	18	43	17

06.3940.6041

Zubehör / accessory:

Heizelement/ heating element 140-250 V / 270 W

55.0096.6044

Heizelement/ heating element 100-120 V / 230 W

55.0096.9990

Heizelement mit Regler/

heating element adjustable 230 V / 550 W

06.2095.6046

Brennstoffdosenhalter / burner holder

06.3940.6039



Chafing Dish, "Manhattan" CHANGE

Chafing Dish, "Manhattan"
Chafing Dish, "Manhattan"
Chafing Dish, "Manhattan"
Chafing Dish, "Manhattan"

passend für Einsätze bis Tiefe 10 cm /
fitting for inserts up to depth 4 in.

GN 1/1, Rolltopdeckel, elektrisch und Brennstoff beheizbar, Deckel
versenkbar /

GN 1/1, full rolltop cover, electrically and sterno heated, cover
immersible

Cromargan®, teilmattiert, Füße und Griffe im 4-Kantprofil /
stainless 18/10, partly satin finished, handles and feet profil 4-cornered
ohne Einsätze / w/o inserts

Höhe	height	Größe mit Griffen	size with handles
cm	in.	cm	in.
45,6	18	74 x 38	28 1/4 x 15

06.3335.6041

Zubehör / accessory:

Heizelement/ heating element 230 V / 600 W

55.0097.6044

Heizelement/ heating element 120 V / 600 W

55.0097.9990

Heizelement mit Regler/

heating element adjustable 230 V / 700 W

06.3286.6046

Brennstoffdosenhalter / burner holder

06.3322.6039





**Chafing Dish, "Manhattan", rund
CHANGE**

Chafing Dish, "Manhattan", round
Chafing Dish, "Manhattan", rond
Chafing Dish, "Manhattan", redondo
Chafing Dish, "Manhattan", rotondo

passend für Einsätze bis Tiefe 10 cm /
fitting for inserts up to depth 4 in.

rund, Rolltopdeckel, elektrisch und Brennstoff beheizbar, Deckel
versenkbar /
round, full rolltop cover, electrically and sterno heated, cover
immersible

Cromargan®, teilmattiert, Füße und Griff im 4-Kantprofil /
stainless 18/10, partly satin finished, handle and feet profil 4-cornered

Höhe	height	Ø	Ø	
cm	in.	cm	in.	
46	18	43	17	06.3945.6041

Zubehör / accessory:

Heizelement/ heating element 140-250 V / 270 W	55.0096.6044
Heizelement/ heating element 100-120 V / 230 W	55.0096.9990
Heizelement mit Regler/ heating element adjustable 230 V / 550 W	06.2095.6046
Brennstoffdosenhalter / burner holder	06.3940.6039



Breite Aufliegerahmen: 35,5 mm
width supporting frame: 1 3/8 in.



Chafing Dish „Metropolitan“, Thekeneinbau

Chafing Dish, to be built into counter
Chafing Dish, pour montage en comptoir
Chafing Dish, encastrado
Chafing Dish, emportable

passend für Einsätze bis Tiefe 10 cm /
fitting for inserts up to depth 4 in.

GN 1/1, Rolltopdeckel, elektrisch beheizbar /
GN 1/1, full rolltop cover, electrically heated

Cromargan® / stainless 18/10
ohne Einsätze / w/o inserts

Höhe	height	Größe	size	
cm	in.	cm	in.	
17	6 3/4	65 x 47	25 5/8 x 18 1/2	06.3266.6041

Zubehör / accessory:

Heizelement/ heating element 230 V / 600 W	55.0097.6044
Heizelement/ heating element 120 V / 600 W	55.0097.9990
Heizelement mit Regler/ heating element adjustable 230 V / 700 W	06.3286.6046

Ausschnittmaße / cut out size



Bitte Heizelement und Brennstoffdosenhalter separat bestellen. Einzelteile (Seite 231) /
Please order heating elements and burner holder separately. Spare parts (page 231)



Portions-Chafing Dish „Metropolitan“

Chafing Dish, S
Chafing Dish, S
Chafing Dish, S
Chafing Dish, S

passend für alle handelsüblichen Porzellanteller mit \varnothing 23 cm, beheizbar mit Teelichte (nicht enthalten) / suitable for all porcelain plates \varnothing 9 in., heated by tealights (not included)

rund, Rolltopdeckel, mit 2 Teelichten beheizbar / round, full rolltop cover, heated by 2 tealights

Cromargan® / stainless 18/10
ohne Einsätze / w/o inserts

Höhe	height	\varnothing	\varnothing
cm	in.	cm	in.
29	11 $\frac{1}{2}$	26	10 $\frac{1}{4}$

06.3306.6040



Breite Aufliegerahmen: 40 mm
width supporting frame: 1 $\frac{1}{2}$ in.



Draufsicht / top view

Ausschnittmaße / cut out size

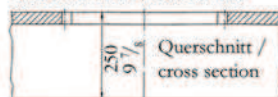
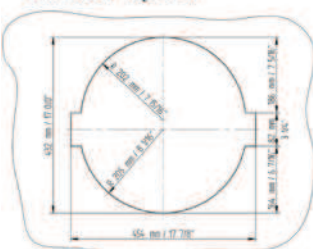

Chafing Dish „Metropolitan“, Thekeneinbau

Chafing Dish, to be built into counter
Chafing Dish, pour montage en comptoir
Chafing Dish, encastrado
Chafing Dish, emportable

passend für Einsätze bis Tiefe 10 cm / fitting for inserts up to depth 4 in.

rund, Rolltopdeckel, elektrisch beheizbar / round, full rolltop cover, electrically heated

Cromargan® / stainless 18/10
ohne Hezelement, ohne Einsätze / w/o heating element, w/o inserts

Höhe	height	\varnothing	\varnothing
cm	in.	cm	in.
18,3	7 $\frac{1}{4}$	48	18 $\frac{7}{8}$

06.3290.6041

Zubehör / accessory:

Hezelement/ heating element 140-250 V / 270 W

55.0096.6044

Hezelement/ heating element 100-120 V / 230 W

55.0096.9990

Hezelement mit Regler/

heating element adjustable 230 V / 550 W

06.2095.6046



**Chafing Dish, mit Domdeckel
ECONOMY**

Chafing Dish, conventional standard cover
Chafing Dish, avec couvercle standard
Chafing Dish, tapa estándar
Chafing Dish, con coperchio standard

passend für Einsätze bis Tiefe 10 cm, Deckel zu allen 4 Seiten
hochstellbar /
fitting for inserts up to depth 4 in., lid can be raised on all 4 sides

GN 1/1, stapelbar, Domdeckel, elektrisch und Brennstoff beheizbar /
GN 1/1, stackable, conventional standard cover, electrically and sterno
heated

Cromargan® matt / stainless 18/10 satin finished
ohne Einsätze / w/o inserts

Höhe mit Griff	height with handle	Größe mit Griffen	size with handles	
cm	in.	cm	in.	
32	12 1/2	62 x 35	24 1/2 x 13 3/4	06.3322.6230

Zubehör / accessory:

Heizelement/ heating element 230 V / 600 W	55.0097.6044
Heizelement/ heating element 120 V / 600 W	55.0097.9990
Heizelement mit Regler/	
heating element adjustable 230 V / 700 W	06.3286.6046
Brennstoffdosenhalter / burner holder	06.3322.6039
Heizelement/ heating element 230 V / 1000 W	06.2082.6044
Adapter für Elektroheizteil /	
holder for heating element	06.3272.6039



**Chafing Dish, mit Klappdeckel
ECONOMY**

Chafing Dish, 1/2 rolltop cover
Chafing Dish, avec couvercle rabattable
Chafing Dish, con tapa abatible
Chafing Dish, con coperchio ribaltabile

passend für Einsätze bis Tiefe 10 cm /
fitting for inserts up to depth 4 in.

GN 1/1, Klappdeckel, elektrisch und Brennstoff beheizbar /
GN 1/1, cover, electrically and sterno heated

Cromargan® matt / stainless 18/10 satin finished
ohne Einsätze / w/o inserts

Höhe mit Griff	height with handle	Größe mit Griffen	size with handles	
cm	in.	cm	in.	
36	14 1/4	62 x 35	24 1/2 x 13 3/4	06.3324.6230

Zubehör / accessory:

Heizelement/ heating element 230 V / 600 W	55.0097.6044
Heizelement/ heating element 120 V / 600 W	55.0097.9990
Heizelement mit Regler/	
heating element adjustable 230 V / 700 W	06.3286.6046
Brennstoffdosenhalter / burner holder	06.3322.6039
Heizelement/ heating element 230 V / 1000 W	06.2082.6044
Adapter für Elektroheizteil /	
holder for heating element	06.3272.6039



Bitte Heizelement und Brennstoffdosenhalter separat bestellen. Einzelteile (Seite 231) /
Please order heating elements and burner holder separately. Spare parts (page 231)

Bezeichnung Designation	Artikel-Nummer Order no.	Ausführung execution	Cromargan Stainless 18/10	Teilvergoldet partly gold plated	Deckel cover	Wasserbad- wanne water pan	Einbaurahmen frame	Brennstoffhalter burner holder	Heizelement heating element	Heizelement mit Regler heating element adjustable
Thekeneinbau GN 1/1	06.3266.6040	bis/ till 2015	•		06.3330.6042		06.3266.6045			
Thekeneinbau GN 1/1	06.3266.6041	Neue Bremse/ New Brakes 2015	•		06.3330.6043	06.3319.6231	06.3266.6046		55.0097.6044	06.3286.6046
Thekeneinbau, rund	06.3290.6040	bis/ till 2015	•		06.3283.6042		06.3290.6045			
Thekeneinbau, rund	06.3290.6041	Neue Bremse/ New Brakes 2015	•		06.3940.6043	06.2003.6041	06.3290.6046		55.0096.6044	06.2095.6046
Economy GN 1/1	06.3322.6230		•		06.3322.6232	06.3322.6231		06.3322.6039	55.0097.6044	06.3286.6046
Economy GN 1/1	06.3324.6230		•		06.3324.6232	06.3322.6231		06.3322.6039	55.0097.6044	06.3286.6046
Metropolitan GN 1/1	06.3330.6040	bis/ till 2015	•		06.3330.6042					
Metropolitan GN 1/1	06.3330.6041	Neue Bremse/ New Brakes 2015	•		06.3330.6043	06.3319.6231		06.3322.6039	55.0097.6044	06.3286.6046
Palast GN 1/1	06.3331.6210	bis/ till 2015		•	06.3331.6212 Auf Anfrage / on request	06.3319.6231		06.3322.6039	55.0097.6044	06.3286.6046
Palast GN 1/1	Sonderausführung / special design Auf Anfrage / on request	Neue Bremse/ New Brakes 2015		•	Sonderausführung / special design Auf Anfrage / on request					
Basic GN 1/1	06.3333.6040	bis/ till 2015	•		06.3333.6042					
Basic GN 1/1	06.3333.6041	Neue Bremse/ New Brakes 2015	•		06.3333.6043	06.3319.6231		06.3322.6039	55.0097.6044	06.3286.6046
Manhattan GN 1/1	06.3335.6040	bis/ till 2015	•		06.3335.6042					
Manhattan GN 1/1	06.3335.6041	Neue Bremse/ New Brakes 2015	•		06.3335.6043	06.3319.6231		06.3322.6039	55.0097.6044	06.3286.6046
Metropolitan rund	06.3940.6040	bis/ till 2015	•		06.3940.6042					
Metropolitan rund	06.3940.6041	Neue Bremse/ New Brakes 2015	•		06.3940.6043	06.2003.6041		06.3940.6039	55.0096.6044	06.2095.6046
Palast rund	06.3941.6210	bis/ till 2015		•	06.3941.6212 Auf Anfrage / on request	06.2003.6041		06.3940.6039	55.0096.6044	06.2095.6046
Palast rund	Sonderausführung / special design Auf Anfrage / on request	Neue Bremse/ New Brakes 2015		•	Sonderausführung / special design Auf Anfrage / on request					
Manhattan rund	06.3945.6040	bis/ till 2015	•		06.3945.6042					
Manhattan rund	06.3945.6041	Neue Bremse/ New Brakes 2015	•		06.3945.6043	06.2003.6041		06.3940.6039	55.0096.6044	06.2095.6046
combiNation Buffet GN 1/1	06.2446.6040		•		06.2446.6042	06.3322.6231			55.0097.6044	06.3286.6046
combiNation Buffet GN 1/1	06.2423.6040		•			06.3322.6231			55.0097.6044	06.3286.6046
combiNation Buffet GN 1/1	06.2442.6040		•			06.3322.6231				

Bitte bestellen Sie die Heizelemente und Brennstoffdosenhalter separat (s. Katalog Chafing Dish-Zubehör) Please order the heating elements and the burner holder separately. (see catalogue Chafing Dish-Accessory)



Suppenmarmite

soup tureen
marmite à potage
recipiente sopa
zuppiera

passend in Chafing Dish GN 1/1 und HOT & FRESH GN 2/3 /
fitting for chafing dish GN 1/1 and HOT & FRESH GN 2/3

Cromargan® / stainless 18/10

Größe	size	Inhalt	cap.
cm	in.	Ltr.	oz.
36 x 33	14 1/4 x 13	4,5	157,5

Topf f. Aufliegedeckel / pot f. normal lid	06.2007.6041
Aufliegedeckel / normal lid	06.2098.6042
Topf f. Scharnierdeckel / pot f. hinged lid	06.2007.9991
Scharnierdeckel / hinged lid	06.2007.9992
Einsatzring / ring	06.3301.6044

* Artikel einzeln bestellen / please order articles separately



Suppenmarmite

soup tureen
marmite à potage
recipiente sopa
zuppiera

passend in Chafing Dish GN 1/1 und HOT & FRESH GN 2/3 /
fitting for chafing dish GN 1/1 and HOT & FRESH GN 2/3

Cromargan® / stainless 18/10

Größe	size	Inhalt	cap.
cm	in.	Ltr.	oz.
36 x 33	14 1/4 x 13	9	315

Topf mit Deckel / pot with cover	06.3297.6040
Einsatzring / ring	06.2094.6044

* Artikel einzeln bestellen / please order articles separately



Suppenstation, GN 1/1 mit Deckel

soup tureen, GN 1/1 with lid
marmite à potage, GN 1/1 avec couvercle
recipiente sopa, GN 1/1 con tapa
zuppiera, GN 1/1 con coperchio

passend in Chafing Dish GN 1/1 /
fitting for chafing dish GN 1/1

Größe	size	Inhalt	cap.
cm	in.	Ltr.	oz.
53 x 32,5	20 ³ / ₄ x 12 ³ / ₄	2 x 4,5	2 x 157,5

Ausführung I /quality I

Cromargan® / stainless 18/10
1 Abdeckplatte, 2 Suppentöpfe mit Scharnierdeckel / 1 insert
plate and 2 soup tureens with hinged lid
Komplett / complete

06.2007.9990

Ausführung II /quality II

Cromargan® / stainless 18/10
1 Abdeckplatte und 2 Suppentöpfe mit Deckel / 1 insert plate
and 2 soup tureens with lid
Komplett / complete

06.2007.6040

Ersatzteil / spare part:

Topf f. Scharnierdeckel / pot f. hinged lid

06.2007.9991

Topf f. Aufliegedeckel / pot f. normal lid

06.2007.6041

Scharnierdeckel / hinged lid

06.2007.9992

Aufliegedeckel / normal lid

06.2098.6042

Brille / insert holder

06.2098.6044



Suppenmarmite

soup tureen
marmite à potage
sopera para chafing dish
zuppiera per chafing dish

passend in alle großen runden WMF Chafing Dishes und in den Chafing
Dish HOT & FRESH rund. In 2 Versionen bestellbar: Ring + Topf f.
Aufliegedeckel + Aufliegedeckel / Ring + Topf für Scharnierdeckel +
Scharnierdeckel. /

fitting in all big round WMF chafing dishes and in Chafing Dish
HOT & FRESH round. To be ordered in 2 versions: ring + pot f. normal lid +
cover / ring + pot f. hinged lid + hinged cover.

Cromargan® / stainless 18/10

Inhalt	cap.	Ø	Ø
Ltr.	oz.	cm	in.
4,5	157,5	34	13 ¹ / ₂

Ring / ring

55.0068.6040

Topf f. Aufliegedeckel / pot f. normal lid

06.2007.6041

Aufliegedeckel / normal lid

06.2098.6042

Topf f. Scharnierdeckel / pot f. hinged lid

06.2007.9991

Scharnierdeckel / hinged lid

06.2007.9992

* Artikel einzeln bestellen / please order articles separately



Suppenmarmite

soup tureen
marmite à potage
sopera para chafing dish
zuppiera per chafing dish

passend in alle großen runden Chafing Dishes von WMF und den Chafing Dish HOT & FRESH rund / fitting for all big round WMF chafing dishes and in chafing dish HOT & FRESH round

Cromargan® / stainless 18/10

Inhalt	cap.	Ø	Ø
Ltr.	oz.	cm	in.
9	315	34	13 1/2

Topf mit Deckel / pot with cover

06.3297.6040

Ring / ring

06.2087.6044

* Artikel einzeln bestellen / please order articles separately



Porzellan-Einsatz, geteilt

porcelain insert, divided
intérieur en porcelaine, divisé
recipiente de porcelana, dividido
interno in porcellana, ripartito

passend in alle großen runden Chafing Dishes von WMF / fitting for all big round WMF chafing dishes

Porzellan / porcelain

Höhe	height	Inhalt	cap.	Ø	Ø
cm	in.	Ltr.	oz.	cm	in.
7	2 3/4	2 x 1,75	2 x 62	33,5	13 1/4

60.3073.9990



Porzellan-Einsatz

porcelain insert
intérieur en porcelaine
interior porcelana
interno in porcellana

passend in alle großen runden Chafing Dishes von WMF / fitting for all big round WMF chafing dishes

Porzellan / porcelain

Höhe	height	Inhalt	cap.	Ø	Ø
cm	in.	Ltr.	oz.	cm	in.
7	2 3/4	3,75	131,3	33,5	13 1/4

60.3072.9990

Porzellan-Einsätze

porcelain insert
intérieur en porcelaine
interior de porcelana
interno in porcellana

Porzellan weiß / porcelain white

Inhalt	cap.	Ø	Ø
Ltr.	oz.	cm	in.
1,5	52,5	20	8

60.3004.0690



Einsatz für Chafing Dish

insert for chafing dish
intérieur pour chafing dish
depósito para chafing dish
inserto piatto chafing dish

passend in alle großen runden Chafing Dishes von WMF /
fitting for all big round WMF chafing dishes

Cromargan® / stainless 18/10

Höhe	height	Inhalt	cap.	Ø	Ø	
cm	in.	Ltr.	oz.	cm	in.	
8	3 ¹ / ₄	5	175	33,4	13 ¹ / ₄	06.2083.6034
10,5	4 ¹ / ₄	6,5	227,5	33,4	13 ¹ / ₄	06.2083.6033



Platte, rund

platter, round
plat, rond
fuente, redonda
vassoio, rotondo

passend in alle WMF Portions-Chafing Dishes /
fitting for all WMF chafing dishes small size

Cromargan® / stainless 18/10

Ø	Ø
cm	in.
23	9

06.3306.6044





Porzellan-Einsatz, zu Chafing Dish

GN porcelain insert, for chafing dish
 GN intérieur, pour chafing dish
 GN interior porcelana, para chafing dish
 GN interno in porcellana, per chafing dish

Beachten: Gastronorm-Einsätze passen **nicht** in die Eiswanne von combiNation buffet! /
 GN inserts do **not** fit in the ice tray of combiNation buffet!

Porzellan / porcelain

Porzellaneinsatz GN ³/₆ / porcelain insert GN ³/₆

Größe cm	size in.	Inhalt Ltr.	cap. oz.	Höhe cm	height in.	
35,4 / 17,4 x 32,5 / 16,2	14 (7) x 12 ³ / ₄	0,7	24,5	2	³ / ₄	55.0219.9800
(6 ¹ / ₃)						
35,4 / 17,4 x 32,5 / 16,2	14 (7) x 12 ³ / ₄	2,5	87,5	6,5	2 ¹ / ₂	55.0220.9800
(6 ¹ / ₃)						

Porzellaneinsatz GN ¹/₆ / porcelain insert GN ¹/₆

Größe cm	size in.	Inhalt Ltr.	cap. oz.	Höhe cm	height in.	
16,2 x 17,5	6 ¹ / ₃ x 7	0,86	29,1	6,5	2 ¹ / ₂	55.0222.9800

Porzellaneinsatz GN ¹/₄ / porcelain insert GN ¹/₄

Größe cm	size in.	Inhalt Ltr.	cap. oz.	Höhe cm	height in.	
26,5 x 16,2	10 ¹ / ₂ x 6 ² / ₃	1,2	40,6	6,5	2 ¹ / ₂	55.0226.9800

Einsatz GN ¹/₃ / insert GN ¹/₃

Größe cm	size in.	Inhalt Ltr.	cap. oz.	
2 x 17,5 x 32,5	³ / ₄ x 7 x 12 ³ / ₄	0,4	14	60.3055.9990
6,5 x 17,5 x 32,5	2 ¹ / ₂ x 7 x 12 ³ / ₄	1,9	64,2	60.3047.9990

Einsatz GN ¹/₂ / insert GN ¹/₂

Größe cm	size in.	Inhalt Ltr.	cap. oz.	
2 x 26,5 x 32,5	³ / ₄ x 10 ¹ / ₂ x 12 ³ / ₄	0,7	24,5	60.3054.9990
6,5 x 26,5 x 32,5	2 ¹ / ₂ x 10 ¹ / ₂ x 12 ³ / ₄	3,3	111,54	60.3045.9990

Einsatz GN ²/₃ / insert GN ²/₃

Größe cm	size in.	Inhalt Ltr.	cap. oz.	
2 x 35,4 x 32,5	³ / ₄ x 14 x 12 ³ / ₄	0,8	28	60.3056.9990
6,5 x 35,4 x 32,5	2 ¹ / ₂ x 14 x 12 ³ / ₄	4,65	157,17	60.3046.9990

Einsatz GN ¹/₁ / insert GN ¹/₁

Größe cm	size in.	Inhalt Ltr.	cap. oz.	
2 x 53 x 32,5	³ / ₄ x 20 ³ / ₄ x 12 ³ / ₄	1,4	49	60.3053.9990
6,5 x 53 x 32,5	2 ¹ / ₂ x 20 ³ / ₄ x 12 ³ / ₄	7,3	246,74	60.3044.9990

Einsatz GN ²/₄ / insert GN ²/₄

Größe cm	size in.	Inhalt Ltr.	cap. oz.	
2 x 16 x 53	³ / ₄ x 6 ¹ / ₄ x 20 ³ / ₄	0,7	24,5	60.3057.9990
6,5 x 16 x 53	2 ¹ / ₂ x 6 ¹ / ₄ x 20 ³ / ₄	2,5	87,5	60.3048.9990

Gastronorm-Einsatz, zu Chafing Dish

GN insert, for chafing dish

GN intérieur, pour chafing dish

GN interior, para chafing dish

GN interno, per chafing dish

Beachten: Gastronorm-Einsätze passen **nicht** in die Eiswanne von combiNation buffet, sondern nur in mittlere und hohe Rahmen! / GN inserts do **not** fit in the ice tray of combiNation buffet, but only fit in frames medium and high!

Edelstahl 18/10 / stainless 18/10



Einsatz GN 1/3 / insert GN 1/3

Größe cm	size in.	Inhalt Ltr.	cap. oz.	
6,5 x 17,5 x 32,5	2 1/2 x 7 x 12 3/4	2,4	84	19.9955.0577
10 x 17,5 x 32,5	4 x 7 x 12 3/4	3,75	133	19.9955.0578

Einsatz GN 1/2 / insert GN 1/2

Größe cm	size in.	Inhalt Ltr.	cap. oz.	
6,5 x 26 x 32,5	2 1/2 x 10 1/4 x 12 3/4	3,8	133	19.9955.0581
10 x 26 x 32,5	4 x 10 1/4 x 12 3/4	6	210	19.9955.0582

Einsatz GN 2/3 / insert GN 2/3

Größe cm	size in.	Inhalt Ltr.	cap. oz.	
6,5 x 35,4 x 32,5	2 1/2 x 14 x 12 3/4	5,5	192,5	19.9955.0585
10 x 35,4 x 32,5	4 x 14 x 12 3/4	8,5	297,5	19.9955.0586



Einsatz GN 1/1 / insert GN 1/1

Größe cm	size in.	Inhalt Ltr.	cap. oz.	
6,5 x 53 x 32,5	2 1/2 x 20 3/4 x 12 3/4	8,5	297,5	19.9955.0589
10 x 53 x 32,5	4 x 20 3/4 x 12 3/4	13,3	465,5	19.9955.0590





Heizelement

heating element
 plaque électrique
 placa calentadora
 piastra riscaldante

für WMF Chafing Dishes GN 1/1 ohne Rolltop-Deckel /
 suitable for all WMF chafing dishes GN 1/1 without full rolltop cover

Größe	size
cm	in.
24 x 24	9 1/2 x 9 1/2

Heizelement/ heating element 230 V / 1000 W

06.2082.6044



Adapter für Elektroheizteil

holder for heating element
 adaptateur pour plaque électrique
 adaptador para placa calentadora
 adattatore per piastra riscaldante

zum problemlosen Einsatz von Heizelement 06.2082.6044 und
 06.2082.9990 für WMF Chafing Dishes GN 1/1 ohne Rolltop-Deckel /
 suitable for easy use of heating element 06.2082.6044 and
 06.2082.9990 for all WMF chafing dishes GN 1/1 without full rolltop
 cover

Cromargan® / stainless 18/10

Größe	size	Höhe	height
cm	in.	cm	in.
25 x 20	9 3/4 x 7 3/4	7	2 3/4

06.3272.6039



Heizelement

heating element
 plaque électrique
 placa calentadora
 piastra riscaldante

für alle großen runden WMF Chafing Dishes, VDE geprüft /
 suitable for all big round WMF chafing dishes, VDE proved

Größe	size
cm	in.
20 x 20	7 3/4 x 7 3/4

Heizelement/ heating element 140-250 V / 270 W

55.0096.6044

Heizelement/ heating element 100-120 V / 230 W

55.0096.9990

Heizelement mit Regler/
 heating element adjustable 230 V / 550 W

06.2095.6046



Heizelement

heating element
 plaque électrique
 place calentadora
 piastra riscaldante

für WMF Chafing Dishes HOT & FRESH GN 2/3 und rund /
 suitable for WMF chafing dishes HOT & FRESH GN 2/3 and round

Größe	size
cm	in.
25 x 20	9 3/4 x 7 3/4

Heizelement/ heating element 140-250 V / 220 W

55.0095.6044

Heizelement / heating element 120 V / 220 W

55.0135.9990

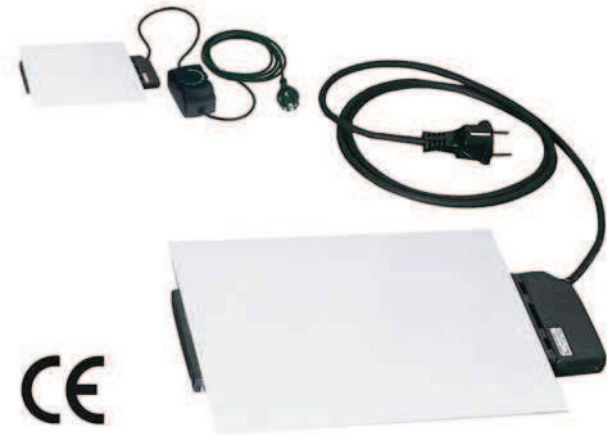

Heizelement

heating element
 plaque électrique
 placa calentadora
 piastra riscaldante

für WMF Chafing Dishes GN 1/1 und HOT & FRESH GN 1/1, VDE geprüft /
 suitable for WMF chafing dishes GN 1/1 and HOT & FRESH GN 1/1, VDE proved

Größe	size
cm	in.
25 x 20	9 3/4 x 7 3/4

Heizelement/ heating element 230 V / 600 W	55.0097.6044
Heizelement/ heating element 120 V / 600 W	55.0097.9990
Heizelement mit Regler/ heating element adjustable 230 V / 700 W	06.3286.6046
Heizelement mit Regler/ heating element adjustable 120 V / 700 W	55.0136.9990



Brennstoffdosenhalter

burner holder
 porte brûleur
 soporte quemador
 fornello

zur problemlosen Umstellung von elektrischer Heizung auf Brennstoff.
 Passend für alle WMF Chafing Dishes GN 1/1 und HOT & FRESH /
 for uncomplicated conversion from electrical to burner heating. Fitting
 for all WMF chafing dishes GN 1/1 and HOT & FRESH

Cromargan® / stainless 18/10

Größe	size
cm	in.
20 x 26 x 8,2	8 x 10 1/4 x 3 1/4

06.3322.6039



Brennstoffdosenhalter

burner holder
 porte brûleur
 soporte quemador
 fornello

zur problemlosen Umstellung von elektrischer Heizung auf Brennstoff.
 Passend für alle runden Chafing Dishes CHANGE /
 for uncomplicated conversion from electrical to burner heating. Fitting
 for all round WMF chafing dishes CHANGE

Cromargan® / stainless 18/10

Größe	size	Höhe	height
cm	in.	cm	in.
12,5 x 20	5 x 8	8,5	3 1/4

06.3940.6039



Brennstoffdose

fuel gel cartidge
 boîtes de gel combustible
 depósito de combustible
 lattine di gel carburante

Großpackung 36 St. /
 large package 36 pcs.

Inhalt	cap.
Ltr.	oz.
je Dose 0,2	each tin 7

60.3002.0690



Besteckablage

rack for utensils
support couverts à servir
soporte cubiertos servir
porta posante

zum Einhängen in die Rahmen aller GN 1/1 Chafing Dishes CHANGE und HOT & FRESH, kann auch ohne Chafing Dish freistehend verwendet werden. /

to hinge in the frames of all GN 1/1 chafing dishes CHANGE and HOT & FRESH, can also be used on its own without Chafing Dish.

Cromargan®, Porzellan weiß / stainless 18/10, porcelain white

Tablett/Besteckhalter / tray/cutlery holder

Größe	size	
cm	in.	
27,9 x 12 x 7,1	11 x 4 ³ / ₄ x 2 ³ / ₄	06.3539.6040

Porzellanschale / porcelain bowl

Größe	size	
cm	in.	
21 x 8,7 x 3,25	8 ¹ / ₄ x 3 ¹ / ₂ x 1 ¹ / ₄	60.3540.9990

* Artikel einzeln bestellen / please order articles separately



Besteckablage

rack for utensils
support couverts à servir
soporte cubiertos servir
porta posante

passend in alle WMF Chafing Dishes GN 1/1 in Standard- und Economy-Ausführung / fitting for all WMF chafing dishes GN 1/1 design Standard and Economy

Cromargan® / stainless 18/10

Größe	size	
cm	in.	
30 x 9	12 x 3 ¹ / ₂	06.3296.6030



Zwischensteg Induktion

connecting shelf
traverse
pasarela
ponticello

passend zu Chafing Dish HOT & FRESH / fitting with Chafing Dish HOT & FRESH

Cromargan® / stainless 18/10

55.0082.6040

Chafing Dish – Besteck

chafing dish serving set
 service pour chafing dish
 cubiertos para chafing dish
 posate chafing dish

Cromargan® / stainless 18/10



Chafing Dish Gabel / chafing dish fork

Länge	length
cm	in.
26	10 ¹ / ₄

12.8386.6042

Chafing Dish Löffel / chafing dish spoon

Länge	length
cm	in.
26	10 ¹ / ₄

12.8386.6041

Chafing Dish Gabel / chafing dish fork

Länge	length
cm	in.
26	10 ¹ / ₄

12.8249.6040

Salatgabel / salad fork

Länge	length
cm	in.
26	10 ¹ / ₄

12.8343.6042

Chafing Dish Gabel / chafing dish fork

Länge	length
cm	in.
32,5	12 ³ / ₄

12.8381.6042

Chafing Dish Löffel / chafing dish spoon

Länge	length
cm	in.
32,5	12 ³ / ₄

12.8381.6041

Fleischgabel / serving fork

Länge	length
cm	in.
32,5	12 ³ / ₄

12.8382.6040

Nudellöffel / pasta serving spoon

Länge	length
cm	in.
31,5	12 ¹ / ₂

12.8383.6040

Chafing Dish Gabel / chafing dish fork

Länge	length
cm	in.
39	15 ¹ / ₄

12.8387.6042

Chafing Dish Löffel / chafing dish spoon

Länge	length
cm	in.
39	15 ¹ / ₄

12.8387.6041



Coffee Urn, "Basic"
CHANGE

coffee urn, "Basic"
coffee urn, "Basic"
urna de café, "Basic"
coffee urn, "Basic"

elektrisch und mit Brennstoff beheizbar. Heizelemente (110-250 V/ 150 W) und Brennstoffhalter bitte separat bestellen. / electrically and sterno heated. Please order heating elements (110-250 V/150W) separately.

Cromargan® / stainless 18/10

Höhe	height	Inhalt	cap.	Ø	Ø	
cm	in.	Ltr.	oz.	cm	in.	
54,5	21½	10	338	26	10¼	06.1520.6040
63,2	25	15	507	26	10¼	06.1525.6040

Zubehör / accessory:

Heizelement Coffee Urn / heating element 19.9999.9879

Brennstoffdose / fuel gel cartidge 60.3002.0690

Inhalt cap.
Ltr. oz.
je Dose 0,2 each tin 7

Brennstoffhalter Coffee Urn / burner holder coffee urn 06.1520.6039

Höhe	height	Ø	Ø
cm	in.	cm	in.
12,8	5	17	6¾



Coffee Urn, "Manhattan"
CHANGE

coffee urn, "Manhattan"
coffee urn, "Manhattan"
urna de café, "Manhattan"
coffee urn, "Manhattan"

elektrisch und mit Brennstoff beheizbar. Heizelemente (110-250 V/ 150 W) und Brennstoffhalter bitte separat bestellen. / electrically and sterno heated. Please order heating elements (110-250 V/150W) separately.

Cromargan® / stainless 18/10

Höhe	height	Inhalt	cap.	Ø	Ø	
cm	in.	Ltr.	oz.	cm	in.	
54,5	21½	10	338	26	10¼	06.1524.6040
63,2	25	15	507	26	10¼	06.1529.6040

Zubehör / accessory:

Heizelement Coffee Urn / heating element 19.9999.9879

Brennstoffdose / fuel gel cartidge 60.3002.0690

Inhalt cap.
Ltr. oz.
je Dose 0,2 each tin 7

Brennstoffhalter Coffee Urn / burner holder coffee urn 06.1520.6039

Höhe	height	Ø	Ø
cm	in.	cm	in.
12,8	5	17	6¾



Brennstoffhalter Coffee Urn CHANGE

burner holder coffee urn
porte brûleur coffee urns
soporte quemador urna de café
fornello coffee urn

passend zu Coffee Urns 10 und 15 l CHANGE /
fitting for coffee urns 10 and 15 l CHANGE

Cromargan® / stainless 18/10

Höhe	height	Ø	Ø
cm	in.	cm	in.
12,8	5	17	6 ³ / ₄

06.1520.6039

Heizelement Coffee Urn

heating element
plaque électrique
placa calentadora
piastra riscaldante

passend zu Coffee Urns 10 und 15 l CHANGE, 140 - 250 V, 150 W,
selbstregelnd /
fitting for coffee urns 10 and 15 l CHANGE, 140 - 250 V, 150 W,
self-regulating



19.9999.9879



Schild mit Kette

name plate with chain
étiquette avec chaîne
etiqueta con cadena
targhetta con aggancio a catenella

passend für Coffee Urns, individuelle Kennzeichnung möglich. Preis auf
Anfrage. /

fitting on Coffee Urns, individual engraving possible. Please ask for
respective costs.

Cromargan® / stainless 18/10

Länge	length
cm	in.
63	24 ³ / ₄

06.3151.6040

WMF CHANGE Cerealien Dispenser: Dreh- und Angelpunkt. Für einen guten Morgen.

WMF CHANGE cereals dispensers:
Where it's all at. For a good morning.

Zu einem erfrischenden Start in den Tag gehören eine abwechslungsreiche Ernährung und ein schöner Anblick. Für beides sorgt der WMF CHANGE Cerealien Dispenser als glänzender Energiespender auf dem Frühstücksbuffet. Seine ausgewogene Mischung aus Form und Funktion verbindet sich zu zwei Platz sparenden Produktvarianten.

A varied diet and good looks are important for a vigorous start to the day. Both are in place with a WMF CHANGE cereals dispenser as a glamorous energy-giving centrepiece on the breakfast buffet. Its balanced combination of form and function merges into two space-saving product variants.



Spielend einfache Frische.

Die hygienischen Behälter sind leicht zu entnehmen, nachzufüllen und komplett spülmaschinengeeignet. Einfach am Bedienknopf drehen und die portionierte Entnahme der verschiedenen Müsli- und Getreideflocken regelt sich von selbst.

Totally convenient freshness.

The hygienic containers are easy to remove and refill, as well as being completely dishwasher-safe. Simply turn the knob to dispense a measured helping of muesli or the cereal of your choice.

Veredelte Frühschicht.

Das hochwertige Cromargan® der WMF CHANGE Cerealien Dispenser ist je nach Variante mattiert oder poliert. Die drehbare Variante lässt durch die platzsparende Anordnung der Cerealien-Röhren auch auf kleinem Raum keine Frühstückswünsche offen.

Looking good at an early hour.

The high-quality Cromargan® of the WMF CHANGE cereals dispensers can be matte-finished or polished, depending on the version. If space is at a premium, the revolving version with the compact arrangement of the cereals cylinders leaves ample room for everything else that belongs on the breakfast table.

Perfekte Harmonie.

Die Produkte der WMF Collection CHANGE sind variabel und stil-sicher. Egal ob Dispenser, Coffee Urns oder Chafing Dishes, alles passt zusammen und harmonisiert mit jeder Einrichtung.

Perfect harmony.

The products in the WMF CHANGE collection are variable and stylistically flawless. Dispensers, coffee urns and chafing dishes: everything matches and harmonises with any interior fittings.



Produktvarianten Product variants



Reihenlösung
In-line solution



rund/drehbar (nur Modell „BASIC“)
Round/revolving ("BASIC" model only)

Ausführungen CHANGE CHANGE models



„BASIC“



„MANHATTAN“



„PALAST“

(Sonderausführung auf Anfrage.
Special design on request.)



Cerealiendispenser, drehbar „Basic“ CHANGE

cereal dispenser, rotatable, „Basic“
dispenseur de céréales, rotatif, „Basic“
dispensador de cereales, rotativo, „Basic“
dispencer cereali, girabile, „Basic“

mit 3 Behältern, drehbar, portionierte und hygienische Entnahme durch Drehen, leicht zu befüllen, spülmaschinengeeignet, Durchmesser Behälter 11,3 cm; Inhalt jeweils 3,5 l; Unterstellhöhe 9,5 cm /
with 3 containers, turnable, hygienic portioning by turning, easy to refill, dishwasher safe, dia. container 4¹/₂ in.; cap. each container 118,3 oz.; clear height 3³/₄ in.

Gestell Cromargan®, Behälter PMMA farblos /
stand stainless 18/10, container PMMA clear

Höhe	height	Ø	Ø
cm	in.	cm	in.
59,7	23 ¹ / ₂	35,7	14

06.3530.6040

Ersatzteil / spare part:

Cerealienbehälter / container cereal dispenser

06.3530.6041



Cerealiendispenser, Reihenlösung „Basic“ CHANGE

cereal dispenser, in-line „Basic“
dispenseur de céréales, in-line „Basic“
dispensador de cereales, in-line „Basic“
dispencer cereali, in-line „Basic“

mit 3 Behältern, portionierte und hygienische Entnahme durch Drehen, leicht zu befüllen, spülmaschinengeeignet, Durchmesser Behälter 11,3 cm; Inhalt jeweils 3,5 l; Unterstellhöhe 9,5 cm /
with 3 containers, hygienic portioning by turning, easy to refill, dishwasher safe, dia. container 4¹/₂ in.; cap. each container 118,3 oz.; clear height 3³/₄ in.

Gestell Cromargan®, Behälter PMMA farblos /
stand stainless 18/10, container PMMA clear

Größe	size
cm	in.
39 x 25 x 59,7	15 ¹ / ₄ x 9 ³ / ₄ x 23 ¹ / ₂

06.3640.6040

Ersatzteil / spare part:

Cerealienbehälter / container cereal dispenser

06.3530.6041



Cerealiendispenser, Reihenlösung „Manhattan“ CHANGE

cereal dispenser, in-line „Manhattan“
 dispenseur de céréales, in-line „Manhattan“
 dispensador de cereales, in-line „Manhattan“
 dispenser cereali, in-line „Manhattan“

mit 3 Behältern, portionierte und hygienische Entnahme durch Drehen, leicht zu befüllen, spülmaschinengeeignet, Durchmesser Behälter 11,3 cm; Inhalt jeweils 3,5 l; Unterstellhöhe 9,5 cm /
 with 3 containers, hygienic portioning by turning, easy to refill, dishwasher safe, diam. container 4 1/2 in.; cap. each container 118,3 oz.; clear height 3 3/4 in.

Gestell Cromargan®, Behälter PMMA farblos /
 stand stainless 18/10, container PMMA clear

Größe	size
cm	in.
39 x 25 x 59,6	15 1/4 x 9 3/4 x 23 1/2

06.3645.6040

Ersatzteil / spare part:

Cerealienbehälter / container cereal dispenser

06.3530.6041

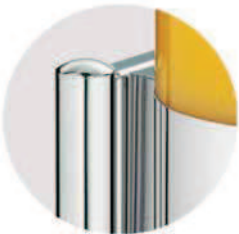

Saftdispenser, „Basic“ CHANGE

juice dispenser, „Basic“
 dispenseur de jus, „Basic“
 dispensador de zumo, „Basic“
 dispenser per succhi di frutta, „Basic“

individuell höhenverstellbar, klare Kennzeichnung, tropffreier, hygienischer Auslauf, Kühlmöglichkeit durch Eiströhre (Zubehör). Attraktive Motive für die Frontseite zum Download unter www.wmf-hotel.de/

individually height adjustable, clear labelling, non dripping hygienic spout, cooling with ice tube (accessory). Attractive motifs for the frontside for download at www.wmf-hotel.de

Gestell Cromargan®, Behälter SAN-Kunststoff transparent /
 stand stainless 18/10, container SAN plastic clear

Mindesthöhe	min. height	Maximalhöhe	max. height	Größe	size
cm	in.	cm	in.	cm	in.
52	20 1/2	60	23 1/2	30,5 x 20	12 x 8

Inhalt mit Eiströhre	cap. incl. ice tube	Inhalt ohne Eiströhre	cap. w/o ice tube
Ltr.	oz.	Ltr.	oz.
5	175	6,5	227,5

06.3130.6040

Zubehör / accessory:

Eiströhre / ice tube

06.3130.6043

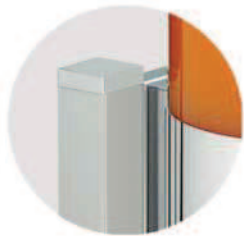

Saftdispenser, "Manhattan" CHANGE

juice dispenser, "Manhattan"
dispenseur de jus, "Manhattan"
dispensador de zumo, "Manhattan"
dispenser per succhi di frutta, "Manhattan"

individuell höhenverstellbar, klare Kennzeichnung, tropffreier, hygienischer Auslauf, Kühlmöglichkeit durch Eisröhre (Zubehör). Attraktive Motive für die Frontseite zum Download unter www.wmf-hotel.de/

individually height adjustable, clear labelling, non dripping hygienic spout, cooling with ice tube (accessory). Attractive motifs for the frontside for download at www.wmf-hotel.de

Gestell Cromargan®, teilmattiert, Behälter SAN-Kunststoff transparent / stand stainless 18/10, partly satin finished, container SAN plastic clear

Mindesthöhe cm	min. height in.	Maximalhöhe cm	max. height in.	Größe cm	size in.
52	20½	60	23½	30,5 x 20	12 x 8

Inhalt mit Eisröhre Ltr.	cap. incl. ice tube oz.	Inhalt ohne Eisröhre Ltr.	cap. w/o ice tube oz.
5	175	6,5	227,5

06.3135.6040

Zubehör / accessory:

Eisröhre / ice tube 06.3130.6043



Milchdispenser, "Basic" CHANGE

milk dispenser, "Basic"
dispenseur de lait, "Basic"
dispensador leche, "Basic"
dispenser latte, "Basic"

individuell höhenverstellbar, klare Kennzeichnung, tropffreier, hygienischer Auslauf, Kühlmöglichkeit durch Eisröhre (Zubehör). Attraktive Motive für die Frontseite zum Download unter www.wmf-hotel.de/

individually height adjustable, clear labelling, non dripping hygienic spout, cooling with ice tube (accessory). Attractive motifs for the frontside for download at www.wmf-hotel.de

Gestell Cromargan®, Behälter SAN-Kunststoff lichtundurchlässig / stand stainless 18/10, container SAN plastic opaque white

Mindesthöhe cm	min. height in.	Maximalhöhe cm	max. height in.	Größe cm	size in.
52	20½	60	23½	30,5 x 20	12 x 8

Inhalt mit Eisröhre Ltr.	cap. incl. ice tube oz.	Inhalt ohne Eisröhre Ltr.	cap. w/o ice tube oz.
5	175	6,5	227,5

06.3390.6040

Zubehör / accessory:

Eisröhre / ice tube 06.3130.6043



Milchdispenser, "Manhattan" CHANGE

milk dispenser, "Manhattan"
dispenseur de lait, "Manhattan"
dispensador leche, "Manhattan"
dispenser latte, "Manhattan"

individuell höhenverstellbar, klare Kennzeichnung, tropffreier, hygienischer Auslauf, Kühlmöglichkeit durch Eisröhre (Zubehör). Attraktive Motive für die Frontseite zum Download unter www.wmf-hotel.de/

individually height adjustable, clear labelling, non dripping, hygienic spout, cooling with ice tube (accessory). Attractive motifs for the frontside for download at www.wmf-hotel.de

Gestell Cromargan®, teilmattiert, Behälter SAN-Kunststoff lichtundurchlässig /

stand stainless 18/10, partly satin finished, container SAN plastic opaque white

Mindesthöhe cm	min. height in.	Maximalhöhe cm	max. height in.	Größe cm	size in.
52	20 ¹ / ₂	60	23 ¹ / ₂	30,5 x 20	12 x 8

Inhalt mit Eisröhre Ltr.	cap. incl. ice tube oz.	Inhalt ohne Eisröhre Ltr.	cap. w/o ice tube oz.
5	175	6,5	227,5

06.3395.6040

Zubehör / accessory:

Eisröhre / ice tube

06.3130.6043



Eisröhre

ice tube
tube à glace
tubo para hielo
tubo in acciaio

mit Crash Ice zu befüllen. Passend zu allen Saft- und Milchdispensern CHANGE /

to be filled up with crash-ice. Fitting for all juice and milk dispensers CHANGE

Cromargan® / stainless 18/10

Inhalt Ltr.	cap. oz.	Höhe cm	height in.	Ø cm	Ø upper in.
1	35	27	10 ³ / ₄	7,5	35

06.3130.6043

**Softbar, mit Gläserbord**

juice bar, with glass holder
bar à jus de fruit, avec étagère pour verres
set para zumos, con portavasos
set girevole per succhi di frutta

bestehend aus: Gestell, 4 Kühlpellets /
consisting of: stand, 4 cooling elements

drehbar /
turnable

Cromargan®, Plexiglas / stainless 18/10, plexiglass

Höhe	height	Ø	Ø
cm	in.	cm	in.
47	18½	47	18½

06.3232.6040

Zubehör / accessory:

Glaskrug / glass pitcher

60.3061.9990

Inhalt	cap.
Ltr.	oz.
1,5	52,5

Ersatzteil / spare part:

Kühlpellet / cooling element

19.9999.5850

Ø	Ø
cm	in.
16	6¼

**Glaskrug**

glass pitcher
broc en verre
jarra de cristal
brocca di vetro

2 Stück passen in die Eiswannen GN 1/2, 4 St. in GN 1/1 /
2 pcs. fitting in ice trays GN 1/2, 4 St. in GN 1/1

Glas / glass

Inhalt	cap.	Höhe	height
Ltr.	oz.	cm	in.
2	67	30	11¾

09.4117.2000



Getränkekühler

DIVA

beverage cooler
 seau à boisson
 cubo bebida
 rinfresca bevanda

doppelwandig und stapelbar. Kann verwendet werden mit Kühlelement 55.0125.9990, für 3 Wasser-, Saft-, Milchkaraffen 06.1770.6040, 3 Getränkeflaschen (Bsp. Wasser, Wein, etc.) mit max. 10 cm Flaschendurchmesser, 6 Getränkeflaschen (Bsp. Wasser, Saft, Bier etc.) mit max. 7 cm Flaschendurchmesser /
 double wall and stackable. Can be used with cooling element 55.0125.9990, for 3 water/juice/milk decanter 06.1770.6040, 3 beverage bottles (e.g. water, wine, etc.) with max. 4 in. bottle diameter, 6 beverage bottles (e.g. water, juice, beer, etc.) with max. 2 3/4 in. bottle diameter

Cromargan® / stainless 18/10

Größe cm	size in.	Inhalt Ltr.	cap. oz.	
27,5 x 26,2 x 17	10 ³ / ₄ x 10 ¹ / ₄ x 6 ³ / ₄	7,3	257	55.0124.6040



Kühlelement

DIVA

cooling element
 élément réfrigérante
 elemento refrigerador
 elemento per il ghiaccio

mit Kühlgelfüllung zum Einfrieren. Stapelbar. Kann verwendet werden mit Getränkekühler 55.0124.6040 oder separat, für 3 Wasser-, Saft-, Milchkaraffen 06.1770.6040, 3 Getränkeflaschen (Bsp. Wasser, Wein, etc.) mit max. 10 cm Flaschendurchmesser, 6 Getränkeflaschen (Bsp. Wasser, Saft, Bier etc.) mit max. 7 cm Flaschendurchmesser /
 with cooling core for freezing. Stackable. Can be used with beverage cooler 55.0124.6040 or separately, for 3 water decanter 06.1770.6040, 3 beverage bottles (e.g. water, wine, etc.) with max. 4 in. bottle diameter, 6 beverage bottles (e.g. water, juice, beer, etc.) with max. 2 3/4 in. bottle diameter

Kunststoff / plastic

Größe cm	size in.			
25,3 x 24 x 13,3	10 x 9 ¹ / ₂ x 5 ³ / ₄			55.0125.9990



Karaffe

BASIC

decanter
 carafe
 garrafa

Deckel öffnet und schließt automatisch. /
 Lid opens and closes automatically.

Glas, Cromargan®, Silikon / Glass, Cromargan®, silicone

Höhe cm	height in.	Inhalt Ltr.	cap. oz.	
30	11 ³ / ₄	1	35	06.1770.6040

Ersatzteil / spare part:

Ersatzkaraffe / Replacement decanter **60.1770.9990**

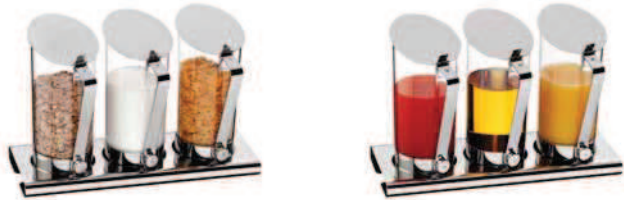

Cerealien-/Saft-Set

set for cereal/juice dispenser
 presentoir a cereales/jus de fruit
 set para cereales/jugo
 set per cereali/succhi

bestehend aus Gestell und 3 Schüttflöten mit Deckel, Inhalt je 2 Ltr., für Saft, Milch oder Cerealien /
 consisting of base and 3 containers with lid, cap. 67,6 oz. each, for juice, milk or cereals



Cromargan®, SAN klar / Cromargan®, SAN clear

Größe	size
cm	in.
44,5 x 17,2 x 29,4	17 1/2 x 6 3/4 x 11 1/2

06.3648.6040

Ersatzteil / spare part:

Gestell, 3 Ausschnitte / base, for 3 inserts

06.3648.6045

Größe	size
cm	in.
44,5 x 17,2 x 3	17 1/2 x 6 3/4 x 1 1/4

Cerealien/Saft-Flöte / cereal/juice flute

06.8253.6040

Höhe	height	Inhalt	cap.	Ø	Ø
cm	in.	Ltr.	oz.	cm	in.
29,4	11 1/2	2	67,6	12,6	5



Buffet-Set, Glas

buffet set, glass
 ensemble buffet, verre
 juego de bufete, cristal
 set per buffet, vetro

bestehend aus Gestell und 3 Gläsern (Inhalt je 0,7 Ltr.) inkl. Deckel mit Beschriftungsmöglichkeit. Beschriftungs-Beispiele zum Download auf www.wmf-hotel.de /
 consisting of base with 3 glasses (cap. 23,66 oz. each) incl. lid. Motifs for labelling available for download on www.wmf-hotel.de

Cromargan®, Glas / stainless 18/10, glass

Größe	size
cm	in.
44,5 x 17,2 x 13	17 1/2 x 6 3/4 x 5

06.8242.6040

Ersatzteil / spare part:

Gestell, 3 Ausschnitte / base, for 3 inserts

06.3648.6045

Größe	size
cm	in.
44,5 x 17,2 x 3	17 1/2 x 6 3/4 x 1 1/4

Glasbehälter / glass bowl

60.8241.9990

Höhe	height	Inhalt	cap.	Ø	Ø
cm	in.	Ltr.	oz.	cm	in.
13	5	0,75	25,35	10,5	4 1/4

Deckel, mit Plexihülle / lid, with plexi cover
 Plexihülle für Deckel / plastic holder for lid

06.8241.6042

60.8241.9996

Buffet-Set, Porzellan

buffet set, porcelain
ensemble buffet, porcelaine
juego de bufete, porcelana
set per buffet, porcellana

bestehend aus Gestell und 3 Porzellanbehältern (Inhalt je 0,65 Ltr.)
inkl. Deckel mit Beschriftungsmöglichkeit. Beschriftungs-Beispiele zum
Download auf www.wmf-hotel.de /
consisting of base with 3 porcelain bowls (cap. 21,97 oz. each) incl. lid.
Motifs for labelling available for download on www.wmf-hotel.de



Cromargan®, Porzellan / stainless 18/10, porcelain

Größe	size	
cm	in.	
44,5 x 17,2 x 13	17 ¹ / ₂ x 6 ³ / ₄ x 5	06.8257.6040

Ersatzteil / spare part:

Gestell, 3 Ausschnitte / base, for 3 inserts 06.3648.6045

Größe	size
cm	in.
44,5 x 17,2 x 3	17 ¹ / ₂ x 6 ³ / ₄ x 1 ¹ / ₄

Porzellanbehälter / porcelain bowl 60.8258.9990

Höhe	height	Inhalt	cap.	Ø	Ø
cm	in.	Ltr.	oz.	cm	in.
13	5	0,65	21,97	10,5	4 ¹ / ₄

Deckel, mit Plexihülle / lid, with plexi cover 06.8241.6042

Plexihülle für Deckel / plastic holder for lid 60.8241.9996



Teller-/Schalengestell

plate and bowl stand
support pour bols à céréales
soporte para platos o fuentes
supporto per piatti e coppe

ohne Glasschalen /
without glass bowls

Cromargan® / stainless 18/10

Höhe	height	Ø Ring	Ø ring
cm	in.	cm	in.
40,4	16	19,5	7 ³ / ₄

06.4394.6040

Zubehör / accessory:

Glasschale, 20 cm / glass bowl, 20 cm 19.9999.8642

Dessertgestell

dessert stand
présentoir à gâteau
soporte plato postre
porta piattini per dessert

ohne Gläser /
w/o glasses

Cromargan® / stainless 18/10

Größe	size	
cm	in.	
40,6 x 7 x 4,9	16 x 2 ³ / ₄ x 2	06.8230.6040

Zubehör / accessory:

Glas S (VPE 6 Stk.) / glass S (unit 6 pcs.) 60.2506.9990



**Dessertgestell
PURE EXCLUSIV**

dessert stand
présentoir à gâteau
soporte plato postre
porta piattini per dessert

in 2 Holzvarianten. Mit 3 Einsätzen für wahlweise Gläser S, Tassen S oder Sahnekännchen (o. Abb.) von KaffeeKultur und Tassen S von CultureCup (o. Abb.). Nicht spülmaschinengeeignet! (ohne Gläser) / in 2 wood versions. With 3 inserts alternatively for glasses S, cups S or creamer (w/o pic.) of CoffeeCulture and cups S CultureCup (w/o pic.). Not dishwasher-safe! (w/o glasses)

Cromargan®, Holz dunkel gebeizt, Holz lackiert / stainless 18/10, wood dark stained, wood lacquered

Menage klein dunkel / stand small dark

Größe	size	
cm	in.	
20,5 x 6,2 x 3,7	8 x 2 1/2 x 1 1/2	55.0039.6040

Menage klein natur / stand small nature

Größe	size	
cm	in.	
20,5 x 6,2 x 3,7	8 x 2 1/2 x 1 1/2	55.0039.6140

Glas S (VPE 6 Stk.) / glass S (unit 6 pcs.)

Höhe	height	Inhalt	cap.	
cm	in.	Ltr.	oz.	
7,4	3	0,1	3,4	60.2506.9990

* Artikel einzeln bestellen / please order articles separately



**Dessertgestell
PURE EXCLUSIV**

dessert stand
présentoir à gâteau
soporte plato postre
porta piattini per dessert

in 2 Holzvarianten. Mit 3 Einsätzen für wahlweise Gläser S, Tassen S (o. Abb.) oder Sahnekännchen von KaffeeKultur und Tassen S von CultureCup (o. Abb.). Nicht spülmaschinengeeignet! / in 2 wood versions. With 3 inserts alternatively for glasses S, cups S (w/o pic.) or creamer of CoffeeCulture and cups S of CultureCup (w/o pic.). Not dishwasher-safe!

Cromargan®, Holz dunkel gebeizt, Holz lackiert / stainless 18/10, wood dark stained, wood lacquered

Menage klein dunkel / stand small dark

Größe	size	
cm	in.	
20,5 x 6,2 x 3,7	8 x 2 1/2 x 1 1/2	55.0039.6040

Menage klein natur / stand small nature

Größe	size	
cm	in.	
20,5 x 6,2 x 3,7	8 x 2 1/2 x 1 1/2	55.0039.6140

Sahnekännchen (VPE 6 Stk.) / creamer (unit 6 pcs.)

Höhe	height	Inhalt	cap.	
cm	in.	Ltr.	oz.	
7	2 3/4	0,1	3,4	55.0033.9990

Deckel mit Ausschnitt / lid with cut-out **55.0031.6040**

Espresso-/Mokkalöffel (VPE 12 Stk.) / demi-tasse spoon (unit 12 pcs.) **54.9901.6040**

* Artikel einzeln bestellen / please order articles separately





Dessertgestell

dessert stand
présentoir à gâteau
soporte platos postre
porta piattini per dessert

passend für Teller bis Ø 16 cm (ohne Teller) /
fitting for plates Ø 6¹/₄ in. (without plates)

Cromargan® / stainless 18/10

Höhe	height	Ø	Ø	Ø Ring	Ø ring
cm	in.	cm	in.	cm	in.
25,5	10	18,5	7 ¹ / ₄	10,5	4 ¹ / ₄

06.4397.6040



Serviergestell

serving stand
présentoir à assiette
soporte platos
portapiatti

passend für Teller Ø 26 cm (ohne Teller) /
fitting for plates Ø 10¹/₄ in. (without plates)

Cromargan® / stainless 18/10

Höhe	height	Ø	Ø	Ø Ring	Ø ring
cm	in.	cm	in.	cm	in.
40	15 ³ / ₄	28,5	11 ¹ / ₄	18,6	7 ¹ / ₄

06.4395.6040



Etagère, 3-teilig PURE

etagere, 3 parts
étagère, en 3 parties
frutero, de 3 pisos
porta frutta, 3 piani

Cromargan® / stainless 18/10

Höhe	height	Ø Schale	Ø bowl
cm	in.	cm	in.
52,5	20 ³ / ₄	46 / 37 / 28	18 / 14 ¹ / ₂ / 11

06.0470.6040



**Mokkaétagère, 3-teilig
PURE**

pastry stand, 3 parts
porte petits fours, en 3 parties
portapastas, de 3 pisos
alzata portadolci, 3 piani

Cromargan® / stainless 18/10

Höhe cm	height in.	Ø Schale cm	Ø bowl in.
22,5	8 ³ / ₄	9 / 14 / 20	3 ¹ / ₂ / 5 ¹ / ₂ / 8

06.6903.6040



**Etagère, 3-teilig
BISTRO**

etagere, 3 parts
étagère, en 3 parties
frutero, de 3 pisos
porta frutta, 3 piani

Cromargan®, Glas / stainless 18/10, glass

Höhe cm	height in.	Ø Schale cm	Ø bowl in.
56	22	30 / 38 / 50	11 ³ / ₄ / 15 / 19 ³ / ₄

06.6893.6040

Ersatzteil / spare part:

Glasschale klein / glass plate small	19.9999.8643
Glasschale mittel / glass plate medium	19.9999.8644
Glasschale groß / glass plate large	19.9999.8645



Etagère

etagere
étagère
frutero articulado
porta frutta

ohne Einsätze, Arme drehbar /
without inserts, insert holders turnable

rostfrei / stainless steel

Höhe cm	height in.	Ringe psc. 4tlg.
51	20	

06.3010.6040



Glasschale, 20 cm

glass bowl, 20 cm
coupe verre glasskin, 20 cm
depósitos de cristal, 20 cm
interno in vetro, 20 cm

passend in Etagère / fitting in etagere 06.3010.6040, 06.3011.6040, 06.4394.6040

Höhe	height	Ø	Ø
cm	in.	cm	in.
8,5	3 ¹ / ₄	20	8

19.9999.8642



Tablett, rund

service tray, round
plateau de service, rond
bandeja, redonda
vassoio, rontondo

passend in Etagère / fitting in etagere 06.3010.6040, 06.3011.6040

Cromargan® / stainless 18/10

Ø außen	outer Ø	Ø innen	Ø inside
cm	in.	cm	in.
29,5	11 ¹ / ₂	24,5	9 ³ / ₄

06.3014.6041



Kühlbehälter, mit Kühlpellet

cooler, with cooling element
coupe réfrigérante, avec élément réfrigérante
recipiente, con acumulador de frio
base, con elemento refrigérante

passend in Etagère / fitting in etagere 06.3010.6040, 06.3011.6040, zum Kühlen von Tablett / to cool tray 06.3014.6041

Cromargan® / stainless 18/10

Ø	Ø
cm	in.
19	7 ¹ / ₂

06.3014.6044

Ersatzteil / spare part:

Kühlpellet / cooling element

19.9999.5850



Früchtekorb

fruit basket
panier à fruits
frutero
fruttiera

passend in Etagère / fitting in etagere 06.3010.6040, 06.3011.6040, nur in Verbindung mit Kühlbehälter / only together with cooler 06.3014.6045 (bitte separat bestellen / please order separately)

Cromargan® / stainless 18/10

Höhe	height	Ø	Ø
cm	in.	cm	in.
22,5	8 ³ / ₄	26	10 ¹ / ₄

06.6521.6040



Plattenständer niedrig, GN 1/1

tray stand low, GN 1/1
 support pour plaques bas, GN 1/1
 soporte platos bajo, GN 1/1
 supporto piatto basso, GN 1/1

kombinierbar mit Servierplatten GN 1/1 06.2431.9990 (CORIAN), 06.7660.6040 (Edelstahl), 60.3053.9990 (Porzellan), 06.2432.9990 (Kunststoff), Kühlakku GN 1/2 und Abdeckhauben 06.2937.6040, 55.0134.6040 /
 combinable with serving plates GN 1/1 06.2431.9990 (CORIAN), 06.7660.6040 (stainless steel 18/10), 60.3053.9990 (Porcelain), 06.2432.9990 (Plastic), cooling block GN 1/2 and covers 06.2937.6040, 55.0134.6040

stapelbar /
 stackable

Cromargan® / stainless 18/10

Größe	size
cm	in.
51 x 30 x 12	20 x 11 ³ / ₄ x 4 ³ / ₄

55.0132.6040



Plattenständer hoch, GN 1/1

tray stand high, GN 1/1
 support pour plaques haut, GN 1/1
 soporte platos alto, GN 1/1
 supporto piatto alto, GN 1/1

kombinierbar mit Servierplatten GN 1/1 06.2431.9990 (CORIAN), 06.7660.6040 (Edelstahl), 60.3053.9990 (Porzellan), 06.2432.9990 (Kunststoff), Kühlakku GN 1/2 und Abdeckhauben 06.2937.6040, 55.0134.6040 /
 combinable with serving plates GN 1/1 06.2431.9990 (CORIAN), 06.7660.6040 (stainless steel 18/10), 60.3053.9990 (Porcelain), 06.2432.9990 (Plastic), cooling block GN 1/2 and covers 06.2937.6040, 55.0134.6040

stapelbar /
 stackable

Cromargan® / stainless 18/10

Größe	size
cm	in.
51 x 30 x 18	20 x 11 ³ / ₄ x 7

55.0133.6040



Kühlakku, GN 1/2

cooling block, GN 1/2
 brique réfrigérante, GN 1/2
 acumulador refrigerador, GN 1/2
 tavoletta per il ghiaccio, GN 1/2

2 Stück für Plattenständer GN 1/1 /
 2 pcs. for trays stands GN 1/1

Kunststoff mit Kühlflüssigkeit / plastic with cooling liquid

Kühlakku, Gastronorm 1/2 /
 cooling block, Gastronorm 1/2

Größe	size
cm	in.
25,5 x 20,3 x 3,2	10 x 8 x 1 ¹ / ₄

60.3065.9990

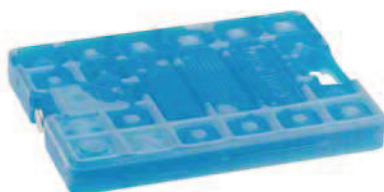

Platten, GN 1/1

platters, GN 1/1
 planche pour recipient, GN 1/1
 fuente, GN 1/1
 piatto, GN 1/1

passend auf Plattenständer hoch und niedrig und alle GN 1/1 Rahmen /
 fitting on tray stand high and low and all GN 1/1 frames



	Größe cm	size in.	Inhalt cap. Ltr. oz.	
CORIAN®	53 x 32,5	20 ³ / ₄ x 12 ³ / ₄		06.2431.9990
Cromargan® GN 1/1 / stainless 18/10	53 x 32,5	20 ³ / ₄ x 12 ³ / ₄		06.7660.6040*
Porzellan / porcelain	2 x 53 x 32,5	3/4 x 20 ³ / ₄ x 12 ³ / ₄	1,4 49	60.3053.9990
Kunststoff / plastic	53 x 32,5	20 ³ / ₄ x 12 ³ / ₄		06.2432.9990

* Passend auf alle GN 1/1 Rahmen und auf Plattenständer niedrig/hoch /
 fitting on all GN 1/1 frames and on tray stands low/high

Abdeckhaube

cover for trays
 cloche pour plateaux
 campana para bandejas
 coperchio adatto per vassoio

mit 2 seitlichen Eingriffen, passend für Tablett GN 1/1 ohne Griffe und
 Plattenständer niedrig/hoch /
 with two side openings, fitting for trays GN 1/1 without handles and on
 tray stands low/high

Kunststoff glasklar, Griff verchromt /
 high quality plastic, handle chrome plated

Größe cm	size in.
55,5 x 35 x 14,5	21 ³ / ₄ x 13 ³ / ₄ x 5 ³ / ₄

06.2937.6040



Abdeckhaube

cover for trays
 cloche pour plateaux
 campana para bandejas
 coperchio adatto per vassoio

halbrollend, passend für Platten GN 1/1 ohne Griffe und Plattenständer
 niedrig/hoch /
 half rolling, fitting for plates GN 1/1 without handles and tray stands
 low/high

Kunststoff glasklar, Griff verchromt /
 high quality plastic, handle chrome plated

Größe cm	size in.
53 x 32,5 x 17	20 ³ / ₄ x 12 ³ / ₄ x 6 ³ / ₄

55.0134.9990





**Tablett, rund
CLASSIC**

serving tray, round
plateau de service, rond
bandeja, redonda
vassoio, rotondo

Ø	Ø
cm	in.
29,5	11 ¹ / ₂
35	13 ³ / ₄
41,7	16 ¹ / ₂

Cromargan®	versilbert
stainless 18/10	silverplated
06.7260.6040	19.7260.6440
06.7261.6040	19.7261.6440
06.7262.6040	19.7262.6440



**Tablett, rund
BISTRO**

serving tray, round
plateau de service, rond
bandeja, redonda
vassoio, rotondo

stapelbar /
stackable

Cromargan® / stainless 18/10

Ø	Ø
cm	in.
42,6	16 ³ / ₄

06.7679.6040



Tablett, oval

serving tray, oval
plateau de service, ovale
bandeja, oval
vassoio, ovale

Cromargan® / stainless 18/10

Größe	size
cm	in.
51,6 x 39,3	20 ¹ / ₄ x 15 ¹ / ₂

06.7265.6040



Tablett, oval

serving tray, oval
plateau de service, ovale
bandeja, oval
vassoio, ovale

Größe	size
cm	in.
22 x 15,5	8 ³ / ₄ x 6
27 x 20	10 ¹ / ₂ x 8
29 x 22,5	11 ¹ / ₂ x 8 ³ / ₄

Cromargan®	versilbert
stainless 18/10	silverplated
06.7540.6040	19.7540.6440
06.7542.6040	19.7542.6440
06.7543.6040	19.7543.6440



**Tablett, oval
BISTRO**

serving tray, oval
plateau de service, ovale
bandeja, oval
vassoio, ovale

stapelbar /
stackable

Cromargan® / stainless 18/10

Größe	size
cm	in.
51,6 x 39	20 ¹ / ₄ x 15 ¹ / ₄

06.7681.6040



**Tablett, oval
CLASSIC**

serving tray, oval
plateau de service, ovale
bandeja, oval
vassoio, ovale

Cromargan® / stainless 18/10

Größe	size
cm	in.
59,5 x 46,7	23 ¹ / ₂ x 18 ¹ / ₂

06.7836.6040*

* Maße ohne Griffe / measures without handles



**Kaffeetablett
PURE**

serving tray
plateau de service
bandeja
vassoio

stapelbar, oval /
stackable, oval

Cromargan® / stainless 18/10

Größe	size
cm	in.
27 x 17	10 ¹ / ₂ x 6 ³ / ₄

06.7550.6040



**Tablett, oval
PURE**

serving tray, oval
plateau de service, ovale
bandeja, oval
vassoio, ovale

passend für Toastständer / suitable for toast rack 06.4280.6040
und Porzellanschale 3geteilt / and for porcelain bowl 3pcs.

60.3538.9990

stapelbar / stackable

Cromargan® / stainless 18/10

Größe	size
cm	in.
24,5 x 12	9 ¹ / ₂ x 4 ³ / ₄

06.7551.6040



**Tablett
URBAN**

tray
plateau
bandeja
vassoio

Cromargan® / stainless 18/10

Größe	size
cm	in.
23 x 10,7	8 x 4 ¹ / ₄

55.0058.6045



**Tablett, Gastronorm,
CLASSIC**

serving tray, Gastronorm
plateau de service, Gastronorm
bandeja, Gastronorm
vassoio, Gastronorm

GN 1¹/₁, rechteckig /
GN 1¹/₁, rectangular

Größe	size
cm	in.
53 x 32,5	20 ³ / ₄ x 12 ³ / ₄

Cromargan®	versilbert
stainless 18/10	silverplated
06.7849.6040	19.7849.6440



**Tablett Gastronorm
CLASSIC**

serving tray Gastronorm
plateau de service Gastronorm
bandeja Gastronorm
vassoio Gastronorm

rechteckig /
rectangular

Cromargan® / stainless 18/10

	Größe	size	
	cm	in.	
GN 1 ¹ / ₁	53 x 32,5	20 ³ / ₄ x 12 ³ / ₄	06.7838.6040
GN 2 ¹ / ₁	65 x 53	25 ¹ / ₂ x 20 ³ / ₄	06.7839.6040

Maße ohne Griffe / measures without handles



Tablett, Gastronorm

serving tray, Gastronorm
 plateau de service, Gastronorm
 bandeja, Gastronorm
 vassoio, Gastronorm

rechteckig /
 rectangular

Cromargan® / stainless 18/10

	Größe cm	size in.	
GN 1/2*	32,5 x 26,5	12 ³ / ₄ x 10 ¹ / ₂	06.7658.6040
GN 1/1**	53 x 32,5	20 ³ / ₄ x 12 ³ / ₄	06.7660.6040
GN 2/1	65 x 53	25 ¹ / ₂ x 20 ³ / ₄	06.7661.6040

* Passend auf alle GN 1/2 Rahmen / fitting on all GN 1/2 frames

** Passend auf alle GN 1/1 Rahmen und auf Plattenständer niedrig/hoch/
 fitting on all GN 1/1 frames and on tray stands low/high

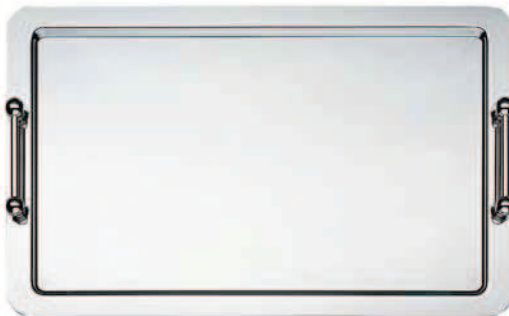
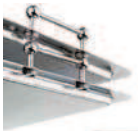

Tablett Gastronorm BISTRO

serving tray Gastronorm
 plateau de service Gastronorm
 bandeja Gastronorm
 vassoio Gastronorm

GN 1/1, stapelbar, rechteckig /
 GN 1/1, stackable, rectangular

Cromargan® / stainless 18/10

Größe cm	size in.	
53 x 32,5	20 ³ / ₄ x 12 ³ / ₄	06.7680.6040



Tablett Gastronorm NEUTRAL

serving tray Gastronorm
 plateau de service Gastronorm
 bandeja Gastronorm
 vassoio Gastronorm

rechteckig / rectangular

Cromargan® / stainless 18/10

Größe cm	size in.	
GN 1/1	53 x 32,5	20 ³ / ₄ x 12 ³ / ₄
GN 2/1	65 x 53	25 ¹ / ₂ x 20 ³ / ₄

Maße ohne Griffe / measures without handles

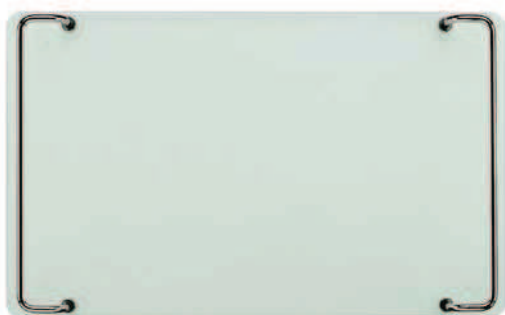

Tablett, rechteckig, Gastronorm

serving tray, rectangular, Gastronorm
 plateau de service, rectangulaire, Gastronorm
 bandeja, rectangular, Gastronorm
 vassoio, rettangolare, Gastronorm

GN 1/1, stapelbar, rechteckig, schnittfest, spülmaschinenfest /
 GN 1/1, stackable, rectangular, resistant against cutting, dishwasher-safe

Kunststoff, Cromargan® - Griffe /
 high quality plastic, handle stainless 18/10

Größe	size
cm	in.
53 x 32,5	20 ³ / ₄ x 12 ³ / ₄

06.7683.6040



Tablett, rechteckig

serving tray, rectangular
 plateau de service, rectangulaire
 bandeja, rectangular
 vassoio, rettangolare

Cromargan® / stainless 18/10

Größe	size
cm	in.
40,1 x 29	15 ³ / ₄ x 11 ¹ / ₂
52,6 x 40,8	20 ³ / ₄ x 16

06.7269.6040

06.7271.6040



**Tablett, rechteckig
 CLASSIC**

serving tray, rectangular
 plateau de service, rectangulaire
 bandeja, rectangular
 vassoio, rettangolare

Cromargan® / stainless 18/10

Größe	size
cm	in.
77,2 x 50,7	30 ¹ / ₂ x 20

06.7842.6040

Maße ohne Griffe / measures without handles



**Tablett, rechteckig
 NEUTRAL**

serving tray, rectangular
 plateau de service, rectangulaire
 bandeja, rectangular
 vassoio, rettangolare

Cromargan® / stainless 18/10

Größe	size
cm	in.
52,6 x 40,8	20 ³ / ₄ x 16

06.8444.6040

Maße ohne Griffe / measures without handles



Tablett, rechteckig

servicing tray, rectangular
plateau de service, rectangulaire
bandeja, rectangular
vassoio, rettangolare

Cromargan® / stainless 18/10

Größe	size
cm	in.
28,5 x 21	11 ¹ / ₄ x 8 ¹ / ₄
33 x 26	13 x 10 ¹ / ₄
42,5 x 31,5	16 ³ / ₄ x 12 ¹ / ₂

06.7585.6040

06.7586.6040

06.7588.6040



Käseglocke

NEUTRAL

cheese dish
cloche à fromage
quesera
porta formaggio

Holzeinsatz Buche / beech wooden insert

	Ø	Ø	
	cm	in.	
passt in Tablett 7262 / fitting tray 7262	36,7	14 ¹ / ₂	60.3103.9990

Plexiglashaube / plastic cover

	Ø	Ø	
	cm	in.	
passt zu Einsatz 3103 / fitting insert 3103	34	13 ¹ / ₂	06.2864.6040



Abdeckhaube

cover for trays
cloche pour plateaux
campana para bandejas
coperchio adatto per vassoio

mit 2 seitlichen Eingriffen, passend für Tablett GN 1/1 ohne Griffe und Plattenständer niedrig/hoch /
with two side openings, fitting for trays GN 1/1 without handles and on tray stands low/high

Kunststoff glasklar, Griff verchromt /
high quality plastic, handle chrome plated

Größe	size
cm	in.
55,5 x 35 x 14,5	21 ³ / ₄ x 13 ³ / ₄ x 5 ³ / ₄

06.2937.6040



Kuchen-/Tortenplatte

cake plate
plat à tarte
plato tarta
piatto da torta

Cromargan® / stainless 18/10

Höhe	height	Ø	Ø
cm	in.	cm	in.
14,5	5 ³ / ₄	36	14 ¹ / ₄

06.4274.6040

Schönheit besteht. Auch aus guter Pflege.

Beauty endures.
And good care helps.



Alle WMF Besteckmodelle und Tafelgeräte sind aus edelsten Materialien für intensiven Gebrauch gefertigt. Auch die Bestecke mit perfekter Glanzversilberung sind spülmaschinenfest und unkompliziert zu pflegen. Doch was täglich zum vollen Einsatz kommt, ist hohen Belastungen ausgesetzt.

Damit WMF Produkte lange Zeit in vollem Glanz erstrahlen, empfehlen wir für Silber, Messing und Kupfer die richtige Pflege. Dazu gehören speziell für WMF entwickelte Pflegemittel, um ein Anlaufen von vornherein zu verhindern oder wieder zu entfernen.

Purargan® Silbertauchbad
Purargan® silver-dip-bath
Inhalt 5 Liter / cap. 175 oz.
14.2826.9990

Purargan® Silber-Pflegetuch
Purargan® silver polishing cloth
14.2822.9990

All WMF cutlery models and tableware are made of the finest materials for intensive usage. Even cutlery with superb high-shine silver plating is dishwasher-safe and easy to look after. But every item designed for everyday use has to withstand a great deal of wear and tear.

We want WMF products to keep looking their best for a long time, so we recommend proper care for silver, brass and copper. The care products specially developed for WMF are ideal for preventing tarnish and for removing it.

Purargan® forte, Pflegemittel für Silber, Messing und Kupfer
Purargan® forte, silver, brass and copper polish
Inhalt 1 Liter / cap. 35 oz.
14.2831.9990

Purargan® C, Pflegemittel für Silber, Messing und Kupfer
Purargan® C, silver, brass and copper polish
Inhalt 1 Liter / cap. 35 oz.
14.2828.9990

Artikel	Seite	Artikel	Seite	Artikel	Seite
"4 for you" - Löffel	104	Dressinglöffel	98	Konsole GN 1/6 mit Fuß	201
Abdeckhaube	251, 257	Eierbecher-Set	168	Konsole GN 2/4	202
Adapter für Elektroheizteil	230	Eierlöffel	99, 168	Konsole GN 3/6	201
Adapter GN 1/1	199	Einsatz für Chafing Dish	227	Korkenzieher	173
Adapter GN 1/3	199	Einzelartikel "KaffeeKultur"	132	Krümelsammler	168
Adapter GN 2/3	199	Eisgefäß	165 - 166	Kuchen-/Tortenplatte	257
Adapter GN 2/4	199	Eislöffel XL	104	Kühlakku	250
Allround "CultureCup-Set"	126	Eisröhre	241	Kühlbehälter	249
Allround "KaffeeKultur-Set"	131	Eisschale	160	Kühlelement	243
Ascher	169	Eisschaufel	99	Käsedose	193
Asia-Set	192	Eiswanne GN 1/1	200	Käseglocke	257
Aufsatz GN 1/2	205	Eiswanne GN 1/3	200	Käsemesser	104
Aufsatz GN 1/3	205	Eiswanne GN 2/3	200	Latte Macchiato-Set	126, 130, 135
Beschriftunghalter hinten	208	Eiswanne GN 2/4	200	LEDlight Adapter GN 1/1	206
Beschriftunghalter vorne	208	Eiswasserkrug	164 - 165	LEDlight Adapter GN 1/3	207
Besteckablage	232	Eiszange	96	LEDlight Adapter GN 2/3	206
Bier-/Wasserglas 11	117	Espresso-Set	125, 130	LEDlight Adapter GN 2/4	207
Biertulpe 11	122	Essig-/Ölgestell	185 - 187	LEDlight Einheit	206
Blumenvase	182 - 183	Essig-/Öl-Menage	188 - 190	Légumier	154 - 155
Bordeaux 35	112, 115, 118	Essig-/Öl-Set	186	Leuchter	177 - 178
Bowlenlöffel	98	Ess-Stäbchen Ablage	105	Longdrink 12	121
Brennstoffdose	231	Ess-Stäbchen Paar	105	Löffel "CultureCup"	129
Brennstoffdosenhalter	231	Ess-Stäbchen Set	105	Löffel "KaffeeKultur"	104
Brennstoffhalter Coffee Urn	235	Etagère	247 - 248	Margarita 97	122
Brotkorb	174 - 175	Etagere GN 1/1	206	Marmeladegestell	163
Brotkorb GN 1/1	204	Flaschenteller	153	Martini 25	117
Brotkorb GN 1/2	205	Fleischgabel	94	Menage	158, 192
Brotkorb GN 1/3	204	Früchtekorb	174, 249	Milchdispenser	240 - 241
Brotkorb GN 2/3	204	Gastronorm-Einsatz	229	Milchkaffee-Set	130
Brotkorb GN 2/4	204	Gebäck- und Servierzange	96	Milchkanne	137 - 138
Brotmesser	100	Getränkekühler	150, 243	Milchkännchen	140
Brotschale	175	Getränkekühlerständer	152	Milch-Zucker-Set	142, 144 - 147
Brotschneidebrett GN 1/1	202	Glas L mit Griff	128	Minibar 47	114, 120
Brücke GN 2/4	205	Glas LATTE (VPE 6 Stk.)	128	Mixdrink 09	113, 121
Buffetgestell	213 - 215	Glas S (VPE 6 Stk.)	128	Mokkaétagère	161 - 163, 248
Buffet-Set	244 - 245	Glasbehälter	134	Nudellöffel	95
Burgunder 99	112, 115	Glaskrug	242	Obstschale	176
Butterkühler	155 - 157	Glasschale	249	Petits Fours-Ständer	161 - 162
Café au Lait-Set	131	Gläser-Set	135	Plastik-Tischnummer	173
Café Crème-Set	125, 130	Happy Spoon	103	Platte	227
Cappuccino-Set	125	Hezelement	230 - 231	Platte GN 1/1	202
Ceralien-/Saft-Set	244	Hezelement Coffee Urn	235	Platte GN 1/3	203
Cerealiendispenser	238 - 239	Honig-/Sahnespender	141	Platte GN 2/3	202
Chafing Dish	211 - 212, 218 - 220, 222	Hummergabel	97	Platte GN 2/4	203
Chafing Dish - Besteck	94, 233	Hummerzange	97	Platte GN 3/6	203
Chafing Dish "Metropolitan"	220 - 221	Hygieneschutz	208	Platten	251
Champagner 29	113, 116, 118	Isolierkanne	141	Plattenständer hoch	250
Chillcup	160	Kaffeekanne	137 - 139	Plattenständer niedrig	250
Cocktail 96	122	Kaffeeblett	148, 253	Platzteller	166 - 167
Coffee Urn	234	Kakao-Set	125	Portions-Chafing Dish	"Metropolitan"
Cognac 18	117	Karaffe	243	Portionsschöpfer	98
Deckel mit Ausschnitt	129, 133	Karaffe 53	124	Porzellanbehälter	129, 134
Dekanter 59	124	Karaffe 57	124	Porzellan-Einsatz	226, 228
Dessertgestell	157 - 159, 245 - 247	Karaffe 58	124	Porzellaneinsatz GN 1/4	207
Destillat 30	116	Kartenhalter	172	Porzellaneinsatz GN 1/6	208
Digestif 23	116	Kartoffellöffel	99	Porzellaneinsatz GN 3/6	207
Doppel-Espresso-Set	131	Kaviarkühler	159	Porzellan-Einsätze	227
Dosenöffner	173	Kaviarlöffel	102	Porzellanschale	148, 163
		Kaviarmesser	103		
		Konsole GN 1/3	201		
		Konsole GN 1/6	201		

Artikel	Seite	Artikel	Seite
Porzellantasse M flach mit Griff	127	Tischnummernständer	170 - 171
Porzellantasse M hoch mit Griff	127	Tischrestebehälter	168
Porzellantasse S mit Griff	127	Toastständer	163
Punchbowl	149	Tortenheber	103
Rahmen GN 1/1	198	Tortennmesser	103
Rahmen GN 1/3	198	Tranchiergabel	101
Rahmen GN 2/3	198	Tranchiermesser	100 - 101
Rahmen GN 3/4	198	Tumbler 15	114, 120
Relish-Pickles-Gestell	164	Tumbler XL 16	120
Rotweinkelch 01	112, 115, 118	Universalschale	155, 176
Rotweinwiege	153	Universalzange	95 - 96
Saftbar	242	Vorlege-/ Aufschnittgabel	100
Saftdispenser	239 - 240	Wasser-/Minibarglas 10	119
Sahne-/Zucker-Set	133	Wasserglas 15 bernstein	123
Sahnegießer	140	Wasserglas 15 oliv	123
Sahnekännchen	134	Wasserglas 15 rauchblau	123
Sahnekännchen (VPE 6 Stk.)	133	Wasserglas 15 rauchgrau	123
Sahne-Zucker-Set	143 - 144	Wein-/Sektküher	150 - 151
Salat-/Vorlegebesteck	94	Weinkorb	153
Salatzange	95	Weinkühler	151
Salz- und Pfeffergestell	185	Weinkühlerständer	152
Salz-/Pfeffer-Set	191	Weissweinkelch 02	112, 115, 118
Salzmühle / Pfeffermühle	184	Windlicht	179 - 180
Salzstreuer / Pfefferstreuer	184	Zahnstocher- und Süßstoffbehälter	169
Saucenlöffel	98	Zahnstocherbehälter	169
Sauciere	154	Zigarrenabschneider	170
Schild mit Kette	235	Zitronenpresse	136
Schnecken gabel	97	Zuckerdose	137 - 140
Schnecken zange	97	Zuckerdosierer	141
Sekt kelch 07	113, 119	Zuckergestell	142 - 143
Senftopf	193	Zuckerstangengefäß	141
Serviergestell	159, 247	Zuckerzange	96
Serviertablett für Zucker	142	Zwischensteg Induktion	232
Sherry/Digestif 04	113		
Sherry/Portwein 04	116		
Short 20	120		
Short 21	121		
Softdrink 14	114, 121		
Speisekartenhalter	172		
Steakbesteck	102		
Steakbesteck SOLID	101		
Steakmesser	102		
Steakmesser*	102		
Suppenmarmite	224 - 226		
Suppenschöpfer	99		
Suppenstation	225		
Tablett	126, 186, 249, 252 - 257		
Tablett Gastronorm	254 - 255		
Tasting/Dessertwein 04	119		
Teeglas	135		
Teekanne	137 - 139		
Teelichtleuchter 3fl. klein	181		
Teesieb	136		
Teesieb-Behälter (VPE 6 Stk.)	136		
Teesieb-Einsatz	136		
Teller-/Schalengestell	245		
Teller cloche	167		
Tischnummer	172		
Tischnummern-Aufsteller	173		

Article	Page	Article	Page	Article	Page
"4 for you" spoon	104	connecting shelf	232	ice tube	241
Adapter GN 1/1	199	console GN 1/3	201	ice-shovel	99
Adapter GN 1/3	199	console GN 1/6	201	insert for chafing dish	227
Adapter GN 2/3	199	console GN 1/6 with feet	201	jam stand	163
Adapter GN 2/4	199	console GN 2/4	202	juice bar	242
all-round "CultureCup Set"	126	console GN 3/6	201	juice dispenser	239 - 240
all-round "KaffeeKultur Set"	131	cooler	249	Label holder front	208
ash tray	169	cooling block	250	Label holder rear	208
Asia set	192	cooling element	243	Latte Macchiato Set	126, 130, 135
Beer/Mineral Water Glass 11	117	cork-screw	173	LEDlight adapter GN 1/1	206
beverage cooler	150, 243	cover for trays	251, 257	LEDlight adapter GN 1/3	207
Bordeaux 35	112, 115, 118	creamer	134, 140	LEDlight adapter GN 2/3	206
bowl for bread	174 - 175	creamer (unit 6 pcs.)	133	LEDlight adapter GN 2/4	207
Brandy Glass 18	117	decanter	243	LEDlight unit	206
Bread basket GN 1/1	204	Decanter 59	124	lemon/orange squeezer	136
Bread basket GN 1/2	205	dessert stand	157 - 159, 245 - 247	lid with cut-out	129, 133
Bread basket GN 1/3	204	Destillate 30	116	lobster fork	97
Bread basket GN 2/3	204	Digestive 23	116	lobster-crack	97
Bread basket GN 2/4	204	dressing ladle	98	Longdrink 12	121
Bread cutting board GN1/1	202	egg cup set	168	Margarita 97	122
bread knife	100	egg spoon	99, 168	Martini 25	117
bread-basket	174 - 175	espresso double set	131	meat fork	101
Bridge GN 2/4	205	espresso set	125, 130	menage	158, 192
buffet set	244 - 245	etagere	247 - 248	menu stand	172
Burgundy 99	112, 115	finger bowl	155, 176	milk dispenser	240 - 241
burner holder	231	flower vase	182 - 183	milk jug	137 - 138
burner holder coffee urn	235	Flute Champagne 07	113, 119	Mineral Water/Minibar 10	119
butter cooler	155 - 157	frame	213 - 215	Minibar 47	114, 120
café au lait set	131	Frame GN 1/1	198	Mixdrink 09	113, 121
café crème set	125, 130	Frame GN 1/3	198	mustard pot	193
caffè Latte set	130	Frame GN 2/3	198	name plate with chain	235
cake knife	103	Frame GN 2/4	198	oil and vinegar set	185 - 190
cake plate	257	fruit basket	174, 249	parmesan jar	193
can opener	173	fruit stand	176	pasta serving spoon	95
candelabra	178	fuel gel cartridge	231	pastry serving tongs	95 - 96
candle stick	177	glass bowl	249	pastry stand	161 - 163, 248
cappuccino set	125	glass dish	134	petits-fours-stand	161 - 162
Carafe 53	124	glass L with handle	128	pie server	103
Carafe 57	124	glass LATTE (unit 6 pcs.)	128	plastic table number	173
Carafe 58	124	glass pitcher	242	plate and bowl stand	245
card holder	172	glass S (unit 6 pcs.)	128	plate cover	167
carving knife	100 - 101	glass set	135	Plate GN 1/1	202
caviar cooler	159	GN insert	229	Plate GN 1/3	203
caviar knife	103	GN porcelain insert	228	Plate GN 2/3	202
caviar spoon	102	gravy boat	154	Plate GN 2/4	203
cereal dispenser	238 - 239	gravy ladle	98	Plate GN 3/6	203
Chafing Dish	211 - 212, 218 - 222	happy spoon	103	plate tray	166 - 167
chafing dish serving set	94, 233	heating element	230 - 231, 235	platter	227
Champagne 29	113, 116, 118	holder for heating element	230	platters	251
cheese dish	257	honey/cream dispenser	141	porcelain bowl 3-section	148, 163
cheese knife	104	hygienic cover	208	porcelain cup M high	
chillcup	160	ice bucket	165 - 166	with handle	127
chopstick set	105	ice cream bowl	160	porcelain cup M low	
chopstick stand	105	Ice pan GN 1/1	200	with handle	127
chopsticks pair	105	Ice pan GN 1/3	200	porcelain cup S with handle	127
cigar cutter	170	Ice pan GN 2/3	200	porcelain dish	129, 134
coaster for bottles	153	Ice pan GN 2/4	200	porcelain insert	226 - 227
Cocktail 96	122	ice spoon XL	104	porcelain insert GN 1/4	207
cocoa set	125	ice tongs	96	porcelain insert GN 1/6	208
coffee pot	137 - 139				
coffee urn	234				

Article	Page	Article	Page
porcelain insert GN $\frac{3}{6}$	207	tealight candle stick	181
potato spoon	99	toast rack	163
punch bowl	149	toothpick- and sweetener	
punch bowl ladle	98	box-holder	169
		toothpick-holder	169
rack for utensils	232	top frame GN $\frac{1}{2}$	205
red wine cradle	153	top frame GN $\frac{1}{3}$	205
Red Wine Goblet 01	112, 115, 118	tray	186, 254
relish or condiment server	164	tray stand high	250
		tray stand low	250
salad serving tongs	95	Tulip Beer Glass 11	122
salad/buffet serving set	94	Tumbler 15	114, 120
salt and pepper set	191	Tumbler 15 amber	123
salt mill / pepper mill	184	Tumbler 15 olive	123
salt shaker / pepper shaker	184	Tumbler 15 smoky blue	123
salt-pepper-set	185	Tumbler 15 smoky grey	123
service tray	249	Tumbler XL 16	120
servicing fork	94, 100		
servicing stand	159, 247	universal dish	155, 176
Servicing stand GN $\frac{1}{1}$	206		
servicing tray	126, 148, 252 - 257	vacuum jug	141
servicing tray for sugar	142	vegetable dish and cover	154 - 155
servicing tray Gastronorm	254 - 255		
set for cereal/juice dispenser	244	water pitcher	164 - 165
Sherry/Digestive 04	113	White Wine Goblet 02	112, 115, 118
Sherry/Port 04	116	wine / champagne cooler	150 - 151
Shot 20	120	wine cooler	151
Shot 21	121	wine-basket	153
silent waiter	168		
single items "KaffeeKultur"	132		
snail fork	97		
snail tweezer	97		
Softdrink 14	114, 121		
soup ladle	98 - 99		
soup tureen	224 - 226		
spoons "CultureCup"	129		
spoons "KaffeeKultur"	104		
stand for beverage cooler	152		
stand for wine/champagne cooler	152		
steak flatware	102		
steak fork and knife SOLID	101		
steak knife	102		
steak knife*	102		
sugar and creamer set	142 - 143		
sugar and milk set	133, 144 - 147		
sugar basin	137 - 140		
sugar dispenser	141		
sugar pack holder	141		
sugar server	142		
sugar set	143		
sugar tongs	96		
table crumbler	168		
table lamp	179 - 180		
table lamp with glass	179		
table number	172 - 173		
table number stand	170 - 171		
Tasting/dessert wine 04	119		
tea glass	135		
tea pot	137 - 139		
tea strainer	136		
tea strainer holder (unit 6 pcs.)	136		
tea strainer insert	136		

Article	Page	Article	Page	Article	Page
Adaptateur GN 1/1	199	Corbeille à pain GN 2/4	204	happy spoon	103
Adaptateur GN 1/3	199	Corniche GN 1/2	205	huilier-vinaigrier	185 - 190
Adaptateur GN 2/3	199	Corniche GN 1/3	205	Incrustation porcelaine GN 1/4	207
Adaptateur GN 2/4	199	coupe à fruits	176	Incrustation porcelaine GN 1/6	208
adaptateur pour plaque électrique	230	coupe à glace	160	Incrustation porcelaine GN 3/6	207
Adaptateur ampoule LED GN 1/1	206	Coupe de champagne 07	113, 119	intérieur en porcelaine	226 - 227
Adaptateur ampoule LED GN 2/3	206	Coupe de vin blanc 02	112, 115, 118	intérieur pour chafing dish	227
Adaptateur ampoule LED GN 1/3	207	Coupe de vin rouge 01	112, 115, 118	kit "CultureCup" polyvalent	126
Adaptateur ampoule LED GN 2/4	207	coupe en porcelaine		kit "KaffeeKultur" polyvalent	131
articles isolés "KaffeeKultur"	132	3 parties	148, 163	kit ASIA	192
assiette de présentation	166 - 167	coupe réfrigérante	249	kit baguettes	105
Bac à glace GN 1/1	200	coupe universelle	155, 176	kit cacao	125
Bac à glace GN 1/3	200	coupe verre glasskin	249	kit café au lait	130 - 131
Bac à glace GN 2/3	200	coupe-cigares	170	kit café crème	125, 130
Bac à glace GN 2/4	200	couteau à caviar	103	kit cappuccino	125
baguettes paire	105	couteau à fromage	104	kit espresso	125, 130
bar à jus de fruit	242	couteau à pain	100	kit espresso double	131
bati	213 - 215	couteau à steak	102	kit latte-macchiato	126, 130
Boisson mélangée 09	113, 121	couteau à steak*	102	latte-macchiato-set	135
Boisson sans alcool 14	114, 121	couteau à tarte	103	légumier et couvercle	154 - 155
boîte de table	168	couteau à viande	100 - 101	Long drink 12	121
boîtes de gel combustible	231	couvercle avec découpe	129, 133	louche	98
bol à punch	149	couvert à salade/servir	94	louche à potage	99
Bordeaux 35	112, 115, 118	couvert à steak	102	Margarita 97	122
Bourgogne 99	112, 115	couvert à steak SOLID	101	marmite à potage	224 - 226
brique réfrigérante	250	crémier	134, 140	Martini 25	117
broc en verre	242	crémier (UV 6 pc.)	133	menagère	158, 192
Cadre GN 1/1	198	cuiller "4 for you"	104	ménagère 2 pièces	185
Cadre GN 1/3	198	cuiller à caviar	102	ménagère 3 pièces	191
Cadre GN 2/3	198	cuiller à glace	99	Minibar 47	114, 120
Cadre GN 2/4	198	cuiller à glace XL	104	moulin à sel / moulin à poivre	184
cafetière	137 - 139	cuiller à oeuf	99, 168	moutardier	193
carafe	243	cuiller à pommes de terre	99	numéro de table	172 - 173
Carafe 53	124	cuiller à punch	98	numéro de table en plastique	173
Carafe 57	124	cuiller à sauce	98	ouvre-boîte	173
Carafe 58	124	cuillère à spaghetti	95	panier à fruits	174, 249
carafe à l'eau	164	cuillers "CultureCup"	129	panier à pain	174 - 175
carafe à l'eau	164 - 165	cuillers "KaffeeKultur"	104	panier à vin	153
cendrier	169	Décanteur 59	124	passoire	136
Chafing Dish	211 - 212, 218 - 222	Dégustation/vin de		passoire à thé	136
Champagne 29	113, 116, 118	dessert 04	119	pelle à gâteau	103
chandelier	177 - 178	dessous de bouteille	153	pince à escargots	97
chandelier avec verrine	179 - 180	Digestif 23	116	pince à gâteau	95 - 96
chandelier bougie		dispenseur de céréales	238 - 239	pince à glace	96
à chauffe-plat	181	dispenseur de jus	239 - 240	pince à homard	97
chillcup	160	dispenseur de lait	240 - 241	pince à salade	95
cloche à fromage	257	Distillat 30	116	pince à sucre	96
cloche pour assiette	167	distributeur à miel / crème	141	Planche à pain GN 1/1	202
cloche pour plateaux	251, 257	élément réfrigérante	243	planche pour recipient	251
Cocktail 96	122	ensemble buffet	244 - 245	plaque électrique	230 - 231, 235
coffee urn	234	étagère	247 - 248	Plaque GN 1/1	202
Cognac 18	117	Etagère GN 1/1	206	Plaque GN 1/3	203
Console GN 1/3	201	étiquette avec chaîne	235	Plaque GN 2/3	202
Console GN 1/6	201	Flûte à bière 11	122	Plaque GN 2/4	203
Console GN 1/6 avec pied	201	fourchette à escargots	97	Plaque GN 3/6	203
Console GN 2/4	202	fourchette à homard	97	plat	227
Console GN 3/6	201	fourchette à viande	94, 100 - 101	plat à tarte	257
Corbeille à pain GN 1/1	204	fromagère	193	plateau	186, 254
Corbeille à pain GN 1/2	205	GN intérieur	228 - 229		
Corbeille à pain GN 1/3	204				
Corbeille à pain GN 2/3	204				

Article	Page	Article	Page
plateau de service	126, 148, 249, 252 - 257	à champagne	152
plateau de service Gastronorm	254 - 255	tasse en porcelaine M haute avec anse	127
plateau de service pour sucre	142	tasse en porcelaine M plate avec anse	127
Pont GN 2/4	205	tasse en porcelaine S avec anse	127
porte brûleur	231	théière	137 - 139
porte brûleur coffee urns	235	tire-bouchon	173
porte menu	172	traverse	232
porte numéro de table	170 - 171	tube à glace	241
porte petits fours	161 - 163, 248	Tumbler 15	114, 120
porte-bouteille	153	Tumbler XL 16	120
porte-carte	172	Unité ampoule LED	206
porte-cure-dents	169	vase à fleurs	182 - 183
porte-cure-dents et récipient pour sucrettes	169	Verre à bière/eau 11	117
pot à lait	137 - 138	Verre à eau 15 ambre	123
pot isotherme	141	Verre à eau 15 bleu fumé	123
pots à lait	140	Verre à eau 15 gris fumé	123
pots à sucriers	141	Verre à eau 15 olive	123
présentoir à assiette	159, 247	Verre à eau/minibar 10	119
présentoir a cereales/ jus de fruit	244	verre à thé	135
présentoir à gâteau	157 - 159, 245 - 247	verre L avec anse	128
presse-citron	136	verre LATTE (UV 6 pc.)	128
Protection hygiénique	208	verre S (UV 6 pc.)	128
ramasse-brosse	168	Xérès /digestif 04	113
rangement pour baguettes	105	Xérès/porto 04	116
récipient en porcelaine	129, 134		
récipient en verre	134		
refraîchisseur à beurre	155 - 157		
refraîchisseur à caviar	159		
saucière	154		
saupoudreuse à sucre	141		
seau à boisson	150, 243		
seau à glace	165 - 166		
seau à vin	151		
seau à vin / champagne	150 - 151		
service à relish	164		
service à sucre	142		
service à sucriers	143		
service pots à lait / sucriers	133, 142 - 147		
service pour chafing dish	94, 233		
set à glass	135		
set de coquetier	168		
Short 20	120		
Short 21	121		
soucoupe pour passoire à thé (UV 6 pc.)	136		
sucrier	137 - 140		
support couverts à servir	232		
support pour bols à céréales	245		
support pour confiture	163		
Support pour inscription arrière	208		
Support pour inscription avant	208		
support pour pain grillé	163		
support pour plaques bas	250		
support pour plaques haut	250		
support pour seau à boisson	152		
support pour seau			

Articulo	Página	Articulo	Página	Articulo	Página
abrelatas	173	cremera (UV 6 p.)	133	Jarra 58	124
acumulador refrigerador	250	cubierto ensalada/servir	94	jarra agua	164 - 165
Adaptador GN 1/1	199	cubierto servir chafing dish	94	jarra de cristal	242
Adaptador GN 1/3	199	cubierto steak	102	jarra isotérmica	141
Adaptador GN 2/3	199	cubierto steak SOLID	101	Jerez/digestivo 04	113
Adaptador GN 2/4	199	cubiertos para chafing dish	233	Jerez/vino de Oporto 04	116
adaptador para placa		culo bebida	150, 243	juego ASIA	192
calentadora	230	culo hielo	165 - 166	juego azucarero	143
artículos diversos		culo vino	151	juego azucarero / cremera	133,
"KaffeeKultur"	132	culo vino / champán	150 - 151		142 - 147
azucarero	137 - 140	cuchara "4 for you"	104	juego cacao	125
azucarero para azúcar en cañas	141	cuchara caviar	102	juego café con leche	130 - 131
		cuchara huevos	99, 168	juego café-crème	125, 130
bajoplato	166 - 167	cuchara pasta	95	juego capuchino	125
bandeja	126, 148,	cucharas "CultureCup"	129	juego de bufete	244 - 245
	186, 249,	cucharas "KaffeeKultur"	104	juego de palillos	105
	252 - 257	cucharon patatas	99	juego espresso	125, 130
bandeja con azucareros	142	cuchillo carne	100 - 101	juego espresso doble	131
bandeja Gastronorm	254 - 255	cuchillo caviar	103	juego latte macchiato	126, 130,
Borgoña 99	112, 115	cuchillo pan	100		135
Burdeos 35	112, 115,	cuchillo queso	104	juego palillos	105
	118	cuchillo steak	102	juego universal para el	
		cuchillo steak*	102	"CultureCup"	126
cafetera	137 - 139	cuchillo tarta	103	juego universal para el	
campana	167	cuenco de porcelana		"KaffeeKultur"	131
campana con pomo	167	3 divisiones	148, 163	juego vasos	135
campana para bandejas	251, 257				
candelabro	178	Decantador 59	124	lechera	137 - 138
candelero	177	depósito de combustible	231	LEDluz Adaptador GN 1/1	206
candelero lamparilla	181	depósito para chafing dish	227	LEDluz Adaptador GN 1/3	207
Cata/vino dulce 04	119	depósitos de cristal	249	LEDluz Adaptador GN 2/3	206
cazo ponche	98	Destilado 30	116	LEDluz Adaptador GN 2/4	207
cazo porciones	98	Digestivo 23	116	LEDluz unidad	206
cazo salsa	98	dispensador de cereales	238 - 239	legumbreira con tapa	154 - 155
cazo sopa	99	dispensador de zumo	239 - 240	linterna con cristal	179 - 180
cenicero	169	dispensador leche	240 - 241		
cesta del pan	174 - 175	dispensador miel / nata	141	Marco GN 1/1	198
cesta vino	153	dosificador azúcar	141	Marco GN 1/3	198
Chafing Dish	211 - 212,			Marco GN 2/3	198
	218 - 222	elemento refrigerador	243	Marco GN 2/4	198
Champán 29	113, 116,	enfriador caviar	159	Margarita 97	122
	118	enfriador para mantequilla	155 - 157	Martini 25	117
Coche hielo GN 1/1	200	Etagère GN 1/1	206	Minibar 47	114, 120
Coche hielo GN 1/3	200	etiqueta con cadena	235	molinillo sal /	
Coche hielo GN 2/3	200	exprimidor para limones	136	molinillo pimienta	184
Coche hielo GN 2/4	200			mostacero	193
Cóctel 96	122	florero	182 - 183		
Combinado 09	113, 121	frutero	174, 176,	número de mesa	172 - 173
Coñac 18	117		247 - 249	número de mesa plastico	173
Consola GN 1/3	201	frutero articulado	248		
Consola GN 1/6	201	fuelle	227, 251	pala para hielo	99
Consola GN 1/6 con pie	201			pala para hielo XL	104
Consola GN 2/4	202	garrafa	243	pala tarta	103
Consola GN 3/6	201	GN interior	229	palillero	169
Copa 12	121	GN interior porcelana	228	palillero y dispensador	
copa cóctel mariscos	160			de edulcorante	169
Copa de vino blanco 02	112, 115,	happy spoon	103	panera	174 - 175
	118			Panera GN 1/1	204
Copa de vino espumoso 07	113, 119	interior colador té	136	Panera GN 1/2	205
Copa de vino tinto 01	112, 115,	interior de porcelana	227	Panera GN 1/3	204
	118	Interior de porcelana GN 1/4	207	Panera GN 2/3	204
copa helado	160	Interior de porcelana GN 1/6	208	Panera GN 2/4	204
Copa pequeña 20	120	Interior de porcelana GN 3/6	207	pasarela	232
Copa pequeña 21	121	interior porcelana	226	pinza caracoles	97
Copa tulipa 11	122			pinza de azúcar	96
cortapuros	170	Jarra 53	124	pinza hielo	96
cremera	134, 140	Jarra 57	124	pinza para ensalada	95

Articulo	Página	Articulo	Página
pinza para langostas	97	de café	235
pinza pasteles	95 - 96	Suplemento GN 1/2	205
placa calentadora	230 - 231, 235	Suplemento GN 1/3	205
place calentadora	230	Tabla de cortar pan GN 1/1	202
Plato GN 1/1	202	tapa con recorte	129, 133
Plato GN 1/3	203	taza de procelana M alta con asa	127
Plato GN 2/3	202	taza de procelana M baja con asa	127
Plato GN 2/4	203	taza de procelana S con asa	127
Plato GN 3/6	203	tenedor bogavante	97
plato tarta	257	tenedor caracoles	97
ponchera	149	tenedor carne	94, 100 - 101
porta aperitivos	164	tetera	137 - 139
porta menus	172	tubo para hielo	241
porta número de mesa	170 - 171	urna de café	234
porta número de mesa (sin número)	171	Vaso de agua 15 ámbar	123
portabotella	153	Vaso de agua 15 azul humo	123
portabotellas	153	Vaso de agua 15 gris humo	123
portacubos champán	152	Vaso de agua 15 verde oliva	123
portapastas	161 - 163, 248	vaso L con asa	128
portatarjetas	172	vaso LATTE (UV 6 p.)	128
portatostadas	163	Vaso para agua/minibar 10	119
Protección higiénica	208	Vaso para cerveza/agua 11	117
Puente GN 2/4	205	vaso S (UV 6 p.)	128
quesera	257	vaso té	135
recipiente	193, 249	Vaso tubo 15	114, 120
recipiente colador	136	Vaso tubo XL 16	120
recipiente colador té (UV 6 p.)	136	vinagreras	185 - 190
recipiente de cristal	134		
recipiente de porcelana	134, 226		
recipiente de procelana	129		
recipiente desperdicios	168		
recipiente sopa	224 - 225		
recipiente universal	155, 176		
recogemigas	168		
Refresco 14	114, 121		
sacacorchos	173		
salsera	154		
servicio condimento	185, 191		
servicio de azúcar	142		
set 3 recipientes	158, 192		
set de huevera	168		
set para cereales/jugo	244		
set para zumos	242		
sopera para chafing dish	225 - 226		
soporte buffet	213 - 215		
soporte cubiertos servir	232		
Soporte para etiqueta parte delantera	208		
Soporte para etiqueta parte trasera	208		
soporte para mermelada	163		
soporte para palillos	105		
soporte para platos o fuentes	245		
soporte plato postre	157 - 159, 245 - 246		
soporte platos	159, 247		
soporte platos alto	250		
soporte platos bajo	250		
soporte platos postre	159, 247		
soporte quemador	231		
soporte quemador urna			

Articolo	Pagina	Articolo	Pagina	Articolo	Pagina
abriscatole	173	raccogliogocce	136	LEDlight Adattatore GN 1/1	206
Accessorio GN 1/2	205	colonna per secchio spumante	152	LEDlight Adattatore GN 1/3	207
Accessorio GN 1/3	205	coltellino per caviale	103	LEDlight Adattatore GN 2/3	206
Adattatore GN 1/1	199	coltello carne	100 - 101	LEDlight Adattatore GN 2/4	207
Adattatore GN 1/3	199	coltello da bistecca	102	LEDlight Unità	206
Adattatore GN 2/3	199	coltello da bistecca*	102	legumiera con coperchio	154 - 155
Adattatore GN 2/4	199	coltello formaggio	104	Longdrink 12	121
adattatore per piastra riscaldante	230	coltello pane	100		
Alzata GN 1/1	206	coltello torta	103	macinasale / macinapepe	184
alzata per frutta	176	contenitore per		Margarita 97	122
alzata porta dolci	161 - 162	colino tè (UV 6 p.)	136	Martini 25	117
alzata portadolci	161 - 163, 248	coperchio adatto per vassoio	251, 257	menage	185, 191
		coperchio con punto aperto		ménage per tapenade	158, 192
		per cucchiaino	129, 133	Mensola GN 1/3	201
base	249	coppa gelato	160	Mensola GN 1/6	201
Bicchiere acqua/birra 11	117	copripiatto con pomolo	167	Mensola GN 1/6 con piede	201
Bicchiere acqua/minibar 10	119	cremiera	140	Mensola GN 2/4	202
bicchiere da tè	135	cucchiaini "CultureCup"	129	Mensola GN 3/6	201
Bicchiere di acqua 15 ambra	123	cucchiaini "KaffeeKultur"	104	mestolino salsa	98
Bicchiere di acqua 15 blu fumo	123	cucchiaino "4 for you"	104	Minibar 47	114, 120
Bicchiere di acqua 15 grigio fumo	123	cucchiaino per bowl	98	Mixdrink 09	113, 121
Bicchiere di acqua 15 verde		cucchiaino per caviale	102		
oliva	123	cucchiaino per patate	99	numero tavolo	172 - 173
bicchiere L con maniglia	128	cucchiaino per uovo	99, 168	numero tavolo in plastica	173
bicchiere LATTE (UV 6 p.)	128	cucchianino per gelato	99		
bicchiere S (UV 6 p.)	128	cucchianino per gelato XL	104	oliera	185 - 190
Bordeaux 35	112, 115, 118	cucchiaino per pasta	95		
		Decanter 59	124	paio bacchette	105
Borgogna 99	112, 115	Digestivo 23	116	pala da torta	103
bowl per punch	149	dispenser cereali	238 - 239	piastra riscaldante	230 - 231, 235
bricchetto per il latte	134	dispenser latte	240 - 241	piatto	251
bricchetto per il latte (UV 6 p.)	133	dispenser per succhi di frutta	239 - 240	piatto da torta	257
brocca di vetro	242	Distillati 30	116	Piatto GN 1/1	202
brocca per acqua	164 - 165			Piatto GN 1/3	203
		elemento per il ghiaccio	243	Piatto GN 2/3	202
				Piatto GN 2/4	203
caffettiera	137 - 139	Flûte 29	113, 116, 118	Piatto GN 3/6	203
Calice da birra 11	122			piatto segneposto	166 - 167
Calice da spumante 07	113, 119	forchetta aragosta	97	pinza per aragoste	97
Calice da vino bianco 02	112, 115, 118	forchetta da antipasto	94, 100	pinza per ghiaccio	96
		forchetta per lumache	97	pinza per lumache	97
Calice da vino rosso 01	112, 115, 118	forchettone	101	pinza per zucchero	96
		formaggiara	193	pinza servire insalata	95
candeliere	177 - 178	fornello	231	pinza servire per dolci	96
candeliere lumino	181	fornello coffee urn	235	pinza universale	95 - 96
Caraffa 53	124	fruttiera	174, 249	Ponte GN 2/4	205
Caraffa 57	124			ponticello	232
Caraffa 58	124	GN interno	229	porta formaggio	257
carraffa termica	141	GN interno in porcellana	228	porta frutta	247 - 248
cavatappi	173			porta piattini per dessert	157 - 159, 245 - 247
cestino per il pane	174 - 175	happy spoon	103	porta posante	232
Cestino portapane GN 1/1	204			porta rifiuti per tavolo	168
Cestino portapane GN 1/2	205	inserto piatto chafing dish	227	porta stuzzicadenti	169
Cestino portapane GN 1/3	204	Inserto porcellana GN 1/4	207	porta stuzzicadenti	
Cestino portapane GN 2/3	204	Inserto porcellana GN 1/6	208	e contenitore per dolcificante	169
Cestino portapane GN 2/4	204	Inserto porcellana GN 3/6	207	portacarta	172
cestino portavino	153	interno in porcellana	226 - 227	portamenu	172
Chafing Dish	211 - 212, 218 - 222	interno in vetro	249	portaoggetti per bacchette	105
				portapane	174 - 175
chillcup	160	lampa da tavola alta		portapiatti	159, 247
ciotola universale	155, 176	c. paralum	180	portasalatini / olive	164
Cocktail 96	122	lampa da tavola alta		porta-toast	163
coffee urn	234	con paralume	179 - 180	posacenero	169
Cognac 18	117	lattiera	137 - 138, 140	posate chafing dish	94, 233
colino per tè	136			posate da bistecca	102
colino per tè con vaschetta		lattine di gel carburante	231		

Articolo	Pagina	Articolo	Pagina
posate da bistecca SOLID	101	tassa di porcellana S	
posate servire insalata	94	con maniglia	127
Protezione igienica	208	Tasting/vino da dessert 04	119
		tavoletta per il ghiaccio	250
raccoglibriciole	168	teiera	137 - 139
ramaiolo	98 - 99	telaio	213 - 215
recipiente di porcellana	129, 134	Telaio GN 1/1	198
recipiente di vetro	134	Telaio GN 1/3	198
rinfrescavino / spumante	151	Telaio GN 2/3	198
rinfresca bevanda	150, 243	Telaio GN 2/4	198
rinfresca-burro	155 - 157	tubo in acciaio	241
rinfresca-caviale	159	Tumbler 15	114, 120
rinfrescavino	151	Tumbler XL 16	120
rinfrescavino / spumante	150 - 151		
		Vasca ghiaccio GN 1/1	200
salsiere	154	Vasca ghiaccio GN 1/3	200
secchiello da ghiaccio	166	Vasca ghiaccio GN 2/3	200
secchiello da ghiaccio	165 - 166	Vasca ghiaccio GN 2/4	200
segnatavola	170 - 171	vaso da fiori	182 - 183
senapiera	193	vassoietto tripartito	
set "CultureCup" completo	126	portazzucchero	148, 163
set "KaffeeKultur" completo	131	vassoio	126, 148, 186, 227, 249, 252 - 257
set ASIA	192		
set bacchette	105	vassoio Gastronorm	254 - 255
set cacao	125	vassoio per zucchero	142
set café au lait	131	versamiele / versalette	141
set café crème	125, 130	versavino	153
set café espresso doppio	131	versazucchero	141
set café latte	130		
set cappuccino	125	zuccheriera	137 - 140, 142
set da bicchieres	135	zuppiera	224 - 225
set da café espresso	125, 130	zuppiera per chafing dish	225 - 226
set girevole per succhi			
di frutta	242		
set latte-macchiato	126, 130, 135		
set lattiera zuccheriera	133, 142 - 147		
set per buffet	244 - 245		
set per cereali/succhi	244		
set portauovo	168		
set zuccheriera	141, 143		
Sherry/digestivo 04	113		
Sherry/Porto 04	116		
Short 20	120		
Short 21	121		
singolo articolo "KaffeeKultur"	132		
Softdrink 14	114, 121		
sottobottiglia	153		
spremilimone	136		
spuntasigari	170		
Supporto etichetta anteriore	208		
Supporto etichetta posteriore	208		
supporto per confetture	163		
supporto per piatti e coppe	245		
supporto piatto alto	250		
supporto piatto basso	250		
Tagliere per pane GN 1/1	202		
targhetta ad appoggio per			
numero tavolo	170		
targhetta con aggancio			
a catenella	235		
tassa di porcellana M			
alta con maniglia	127		
tassa di porcellana M			
bassa con maniglia	127		



Showrooms
Sales offices in Germany

Birkenfeld

Carl-Benz-Straße 10
75217 Birkenfeld
Tel. +49 (0) 72 31 / 4885 500
Fax +49 (0) 72 31 / 4885 590
info@wmf-professional.de

Frankfurt

Otto-Volger-Straße 5
65843 Sulzbach
Tel. +49 (0) 61 96 / 7500 07
Fax +49 (0) 61 96 / 7488 2
verkaufsbuero.sulzbach@wmf.de

Berlin

Am Borsigturm 15
13507 Berlin
Tel. +49 (0) 30 / 4966 511
Fax +49 (0) 30 / 4969 806
verkaufsbuero.berlin@wmf.de

Hamburg

Mönckebergstraße 13
20095 Hamburg
Tel. +49 (0) 40 / 2303 21
Fax +49 (0) 40 / 2368 7731
verkaufsbuero.hamburg@wmf.de

München

Sonnenstraße 19
85764 Oberschleißheim
Tel. +49 (0) 72 31 / 4885 500
Fax +49 (0) 72 31 / 4885 590
info@wmf-professional.de

Tochtergesellschaften
Subsidiaries

WMF in Österreich GmbH

Etrichgasse 13
6020 Innsbruck
Austria
Tel. +43 512 33 02-0
Fax +43 512 33 02-97
gastro@wmf.at

WMF Schweiz AG

Bernstraße 90
8953 Dietikon
Switzerland
Tel. +41 43 322 93 33
Fax +41 43 322 93 99
gastro@wmf.ch

WMF Española, S.A.

Avda. Llano Castellano, 15
28034 Madrid/Spain
Tel. +34 91 334 12 15/14
Fax +34 91 729 32 22
hotel@wmf.es

WMF France S.A.R.L.

13/15 rue Nicolas Ledoux
94000 Creteil
France
Tel. +33 1 49 80 80 10
Fax +33 1 49 80 70 90
info@wmf.fr

WMF United Kingdom Ltd.

31 Riverside Way
Uxbridge
Middlesex UB8 2YF
United Kingdom
Tel. +44 1895 816 100
Fax +44 1895 816 105
tableware@wmf.uk.com

WMF Japan Corp. K.K.

23-5, Nishishinbashi 3-Chome Minato-ku
Tokyo 105-0003
Japan
Tel. +81 3 5408 3301
Tel. +81 3 5408 3302 (hotel)
Fax +81 3 5408 3311
info@wmf-japan.co.jp
wmfj@wmf-japan.co.jp

WMF Shanghai Co. Ltd.

1101-1102 International
Capital Plaza
1318 North SiChuan Road
Hongkou District
Shanghai 200086
P.R. China
Tel. +86 21 5515 5212
Fax +86 21 5515 5220
info@wmf-china.com

proHeq GmbH
WMF Professional

Carl-Benz-Straße 10 · 75217 Birkenfeld · Germany
Phone: +49 7231 4885 500 · Fax: +49 7231 4885 590
info@wmf-professional.de · www.wmf-professional.de

63.8080.9990 · Printed in Germany 02.18

Alle Angaben sind unverbindlich. Druckfehler, Änderungen und Irrtum für den gesamten Inhalt vorbehalten.
All data without obligation. The entire content is subject to misprints, changes and errors.

